

規格書

SPECIFICATION

客 戶 Customer: _____

客戶料號 Customer Part Number: _____

產品型號 Product Part Number: TS-IR01

產品名稱 Product Name: 360°傾倒開關 360°Tilt switch

發行日期 Issue Date: 2016-10-18

規格書版本 Specification Version: A

客戶確認/ Customer Confirm and sign

批准 /APPROVED BY	核准 /CHECKED BY	檢驗/INSPECTED BY

能點確認/EPT Confirm and sign

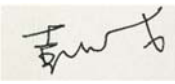
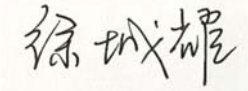
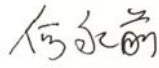
批准 /APPROVED BY	核准 /CHECKED BY	製作/DRAWN BY
		



目錄頁/Table of Content

1. 修訂記錄/Revision History
2. 應用領域/Application
3. 產品特徵/General Features
4. 絕對參數/Absolute maximum ratings
5. 光電參數/Electro-Optical Characteristics
6. 推薦應用電路/Recommended Application Circuit
7. 尺寸規格/Outline Drawing
8. 動作角度/Action Angles



1. 修訂記錄/Revision History

No.	日期 Date	備註 Remark	修訂 Revision
1	20161018	新規格書版本發行 New version issue	A

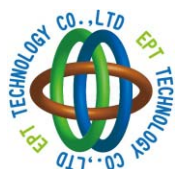

http://www.eptsz.com Tel: +86-755-23244886 Mail: xxkqchi@xxkq.com

Address: 深圳市龍崗區寶龍工業園錦龍一路六號 A 座 7F

7F A Block, No6, Jinlong 1th Road, Baolong Industrial Park, Longgang District, Shenzhen, PRC

本規格書為相應產品作業之標準，在客戶確認後，會作為生產、供貨唯一依據，應在生產前作仔細確認。

This specification would be the standard for the production, after confirmed by clients, it would be the only rule that should be followed, please check it carefully before production.

2. 應用領域/Application

加熱器	Heaters,
電熨斗	Electrical Irons
風扇	Fans,
空氣淨化器	Air Purifiers
加濕器	Humidifiers,
冷卻風機	Cooling Fans,
立式空调或傾倒保护的电器及设备	Air Conditions or other appliances that need to be protected from tipping.

3. 產品特徵/Product features

傾倒與恢復精度高	High precision in detecting tipping angle
反應速度快	Fast response time
高靈敏度	High sensitivity
體積小、成本低	Small in size and low in cost
符合安規標準要求	Satisfying the requirements in Safety Standards
符合相關 RoHS 的相關法規	This product itself will remain within RoHS compliant version

4. 絕對參數/Absolute maximum ratings (Ta=25°C)

參數/Parameter	標記/Symbol	極限值/Limit	單位/Units
發射端/Input(R)	正向電流/Forward Current	I _F	40 mA
	逆向電壓/Reverse Voltage	V _R	5 V
	功耗/Power Dissipation	P _D	70 mW
接收端/Output (Phototransistor)	發射極-集電極電壓/C-E Voltage	V _{CEO}	30 V
	集電極-發射極電壓/E-C Voltage	V _{ECO}	4.5 V
	集電極電流/Collector current	I _C	30 mA
	功率/Collector Dissipation	P _C	80 mW
工作溫度/Operating Temperature	T _{opr}	-25~+80	°C
存儲溫度/Storage Temperature	T _{stg}	-40~+80	°C
壽命/ Working time	Wtime	50000	h
※過爐溫度/Lead soldering Temperature	T _{sol}	260±5	°C

*Time<5s



http://www.eptsz.com Tel: +86-755-23244886 Mail: xxkqchi@xxkq.com

Address: 深圳市龍崗區寶龍工業園錦龍一路六號 A 座 7F

7F A Block, No.6, Jinlong 1th Road, Baolong Industrial Park, Longgang District, Shenzhen, PRC

本規格書為相應產品作業之標準，在客戶確認後，會作為生產、供貨唯一依據，應在生產前作仔細確認。

This specification would be the standard for the production, after confirmed by clients, it would be the only rule that should be followed, please check it carefully before production.

5. 光電參數/Electro-Optical Characteristics (Ta=25°C)

參數/Parameter	標記/Symbol	最小/Min.	典型/Typ.	最大/Max.	單位/Units	條件/Conditions
輸入端/Input	正向電流/Forward Voltage	V_f	--	1.2	1.6	V IF=20mA
	反向電流/Reverse Current	I_r	--	--	10	μ A Vr=5V
	波長/Peak wavelength	λ_p	--	940	--	nm
輸出端/Output	漏電流/Dark Current	I_{CEO}	--	1	100	nA Vce=10V
	飽和電壓/C-E Saturation Voltage	$V_{CE(SAT)}$	--	--	0.4	V IC=2mA, Ee=1mW/cm ²
特性/Transfer Characteristics	電流/Collector Current	$I_{C(ON)}$	0.3	--	--	mA VCE=5V, IF=10mA
	漏電流/Leakage Current	I_{CEO}	--	--	1	μ A VCE=5V, IF=10mA
	上升時間/Rise time	T_r	--	15	--	μ sec VCE=2V IC=1mA
	下降時間/Fall time	T_f	--	15	--	μ sec RL=1K Ω

6 · 推薦應用電路/Recommended Application Circuit

將傾倒開關按如下電路連接，信號端將輸出與開關傾倒狀況一致的電壓信號，此信號作為傾倒控制信號接入MCU I/O埠或其它控制電路，當傾倒角度小於臨界角度時，此信號輸出為低電平，當傾倒角度大於臨界角度時，此信號輸出為高電平，具體參數如下表所示

Connect the tip over switch into below circuit. The sensor will output signals to the MCU I/O port. When detected the change of Signal Output value, MCU will release some orders to do some corresponding actions to protect the unit.

The typical application circuit with power supplier DC 5V show as below:

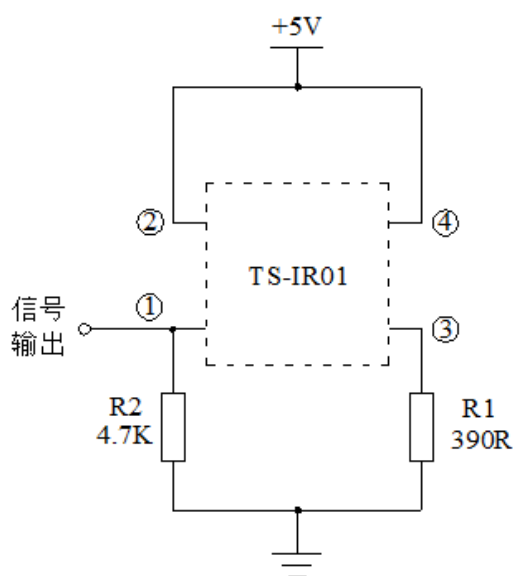

DC 5V 典型应用电路, DC 5V Typical application circuit

工作參數如下表所示 / Below table show the parameters (Ta=25°C)

開關狀態/Switch Status	信號輸出/SG OUT(V)	總電流/Current (mA)	功率消耗/Power (mW)
直立/Erect	< 0.1	<12	<60
傾倒/Tip over	> 4.6	<12	<60

7. 尺寸規格/Outline Drawing

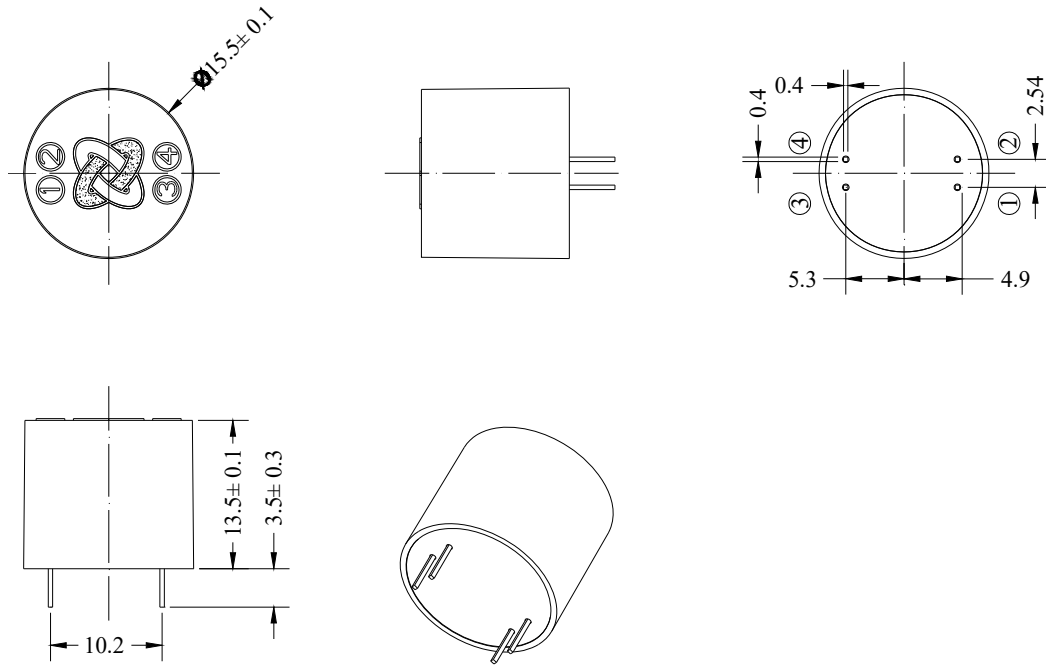

- 備註:
1. 所有尺寸單位均為 mm / All dimensions are in millimeters
 2. 未說明尺寸公差為 $\pm 0.20\text{mm}$ / Dimensional tolerance is $\pm 0.25\text{mm}$
 3. 安裝方式：水平安裝 / Horizontal installation

8. 動作角度/Action Angles

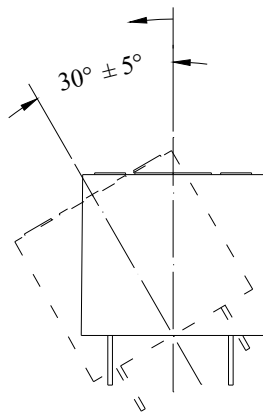

傾倒動作角度: $30^\circ \pm 5^\circ$
Dumping angle: $30^\circ \pm 5^\circ$

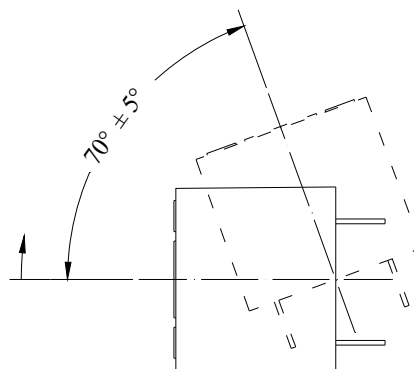

恢復動作角度: $70^\circ \pm 5^\circ$
restore action angle: $70^\circ \pm 5^\circ$



<http://www.eptsz.com> Tel: +86-755-23244886 Mail: xxkqchi@xxkq.com

Address: 深圳市龍崗區寶龍工業園錦龍一路六號 A 座 7F

7F A Block, No6, Jinlong 1th Road, Baolong Industrial Park, Longgang District, Shenzhen, PRC

本規格書為相應產品作業之標準，在客戶確認後，會作為生產、供貨唯一依據，應在生產前作仔細確認。

This specification would be the standard for the production, after confirmed by clients, it would be the only rule that should be followed, please check it carefully before production.

說明/Notes:

1. 此開關具有 360°全方位傾倒檢 /The switch can be detected by 360° full radial direction against tipping over
2. 所有方向具有同一傾倒動作角度：30°±5° / Tip over action angle is 30°±5° in every radial direction
3. 所有方向具有同一恢復動作角度：70°±5° /Recover action angle is 70°±5° in every radial direction



<http://www.eptsz.com> Tel: +86-755-23244886 Mail: xxkqchi@xxkq.com

Address: 深圳市龍崗區寶龍工業園錦龍一路六號 A 座 7F

7F A Block, No6, Jinlong 1th Road, Baolong Industrial Park, Longgang District, Shenzhen, PRC

本規格書為相應產品作業之標準，在客戶確認後，會作為生產、供貨唯一依據，應在生產前作仔細確認。

This specification would be the standard for the production, after confirmed by clients, it would be the only rule that should be followed, please check it carefully before production.