



LMM GOLD *Plus*

Universal Length Measuring Machine
With Laser Measuring System



Designed for Perfection

LMM Gold *Plus*

Universal Length Measuring Machine With Laser Measuring System



Features :

- Very high precision universal length measuring machine provided with highly stable He-Ne Laser interferometer specially designed for large direct measuring range.
- Real time corrections of Environmental parameters including Air temperature, air pressure & humidity.
- On line temperature measurements and computer aided corrections of temperature and measuring force influences.
- Compliance with Abbe's comparator principle.
- Available in two different standard measuring ranges 800 and 1600 mm.
- Granite horizontal bed for structural stability and minimizing effect of the temperature variations.
- Air suspension support for minimizing effect from environment vibrations.
- Air bearing slides for precision rapid movements of measuring head and tail stock.
- Selectable constant measuring force throughout complete operating range.
- Precision work table provided with 5 axis adjustments for easy location of inversion point and specially designed for precision measurements of heavy and long components.
- PC direct reading and user guided powerful windows based Gauge management and measurement software .
- Automatic reversal point recognition for static and dynamic measured value acquisition.
- Large numbers of accessories, specially configured to solve most diverse tasks including threads, tapers, taper threads & gears
- Also available with specially designed $\mu 2d$ probing system (Optional) allows very high precision length measurement in two directions enables measurement of taper gauges / taper thread gauges.

Technical Specifications:	800 / 1600
Measuring Range	
Absolute	525 /1125 mm
Differential	830 /1625 mm
Application Range	
External Plain	0-830 / 1625 mm
Internal Plain	3-675/ 1465 mm
External Taper	up to 780 / 1400 mm
Internal Taper	3-100 mm*
Cylindrical Thread External (d2) (Pitch: 0.2 - 6mm)	1-780 / 1400 mm
Cylindrical Thread Internal (D2) (Pitch: 0.5 - 6mm)	3-675 / 1465 mm
Taper Thread External (d2)	up to 780 / 1400 mm
Taper Thread Internal (D2)	3 - 100 mm*
Gear External (MdK)	7 - 820 / 1610 mm
Gear Internal (MdK)	20 - 675 / 1465 mm
Measuring Instruments	
Micrometers, Dial Indicators, Dial test indicators, Cylinder bore gauges, int. micrometer 3 point	up to 650 / 1340 mm
Internal micrometers - 2 point	up to 615 / 1205 mm

Technical Specifications:	800 / 1600
Performance data	
X axis resolution	0.01 μ m
Measurement uncertainty	$\leq 0.1 + L / 2000 \mu$ m
Measuring force	0.2N - 4.5N, 11N (optional)
Work Table / Vertical Axis	
Work table dimension	160 x 160 mm
Height adjustment	100 mm
Resolution	0.1 μ m
Float	20 mm
Rotation	$\pm 1.5^\circ$
Tilt	$\pm 1.5^\circ$
Load Capacity	25 kg
Dimensions, weight and operational conditions	
L x W x H	1550 / 2350 X 380 x 500 mm
Weight (kg)	250 / 350 kg
Power supply	230 VAC, 50 Hz
Display System	PC based
Compressed Air	3 Bar

Notes:

- In some cases additional standards & optional accessories are required to archive the measuring range.
 - Special accuracies, measuring ranges are available upon request.
- *Higher range possible with additional accessories on request

Octagon ULM Inspect Gauge Measurement and Management Software



Octagon ULM Inspect.

Features :

- Online Data acquisition from ULM
- Facility for thermal error corrections (Manual / Online)
- Automatic Reversal Point detection for dynamic data
- Operator guided measurement program for plain gauges, thread gauges, spline gauges and inspection / calibration measuring instruments like dial indicators, bore gauges and micrometers.
- Calibration report generation in the format complying to ISO/IEC 17025.
- Gauge record management including calibration date, user details, gauge type, due dates etc.



Basic Module:

- Operator guided measurement program for plain and thread gauges.
- Automatic Tolerance calculations for Plain gauges as per IS 3455 & ISO 919 metric thread gauges as per IS 4218, IS 2334 & ISO 965.
- Thread formulae evaluation for over wire / ball measurements.
- Facility for thermal error corrections (Manual / on-line), correction of systematic machine errors.
- Maintenance of Gauge records

Add-on Module 1

- Thread Gauge inspection program.
- This add-on module facilitates automatic tolerance calculations and measurement program for various types of thread gauges including ISO metric M, ISO metric MJ, Unified UN -UNR -UNJ, Withworth, ISO pipe G threads, ISO Trapezoidal, ACME Trapezoidal, Stub trapezoidal, Miniature, Buttress, Knuckle screw threads as per various National & International standards.

Add-on Module 2

- Inspection program for Gauge block / length Bar. This add-on module facilitates automatic tolerance calculations and measurement program for gauge blocks as per ISO 3650, IS 2984 and length Bars as per IS 7014.

Add-on Module 3

- Inspection program for Internal / external micrometers. This add-on module facilitates automatic tolerance calculations and measurement program for Internal micrometer as per IS 2966 and external micrometers as per IS 2967 standards.

Add on Module 4

- Inspection program for Dial indicators & Cy. Bore Gauges. This add-on module facilitates automatic tolerance calculations and measurement program for Dial Indicators as per IS 2092, Dial test indicators as per IS 11498 and Cy. Bore Gauges as per JIS 7515 Standard.

Add on Module 5

- Inspection program for Spline Gauges This add-on module facilitates automatic tolerance calculations and measurement program for spline gauges as per ISO 4156.

Add on Module 6

- Inspection program for Taper Gauges. This add-on module facilitates automatic tolerance calculations and measurement program for Taper gauges as per IS 9475, IS 2251 and Taper thread gauges as per BS 21, ANSI/ASNE B1.20.1(NPT)

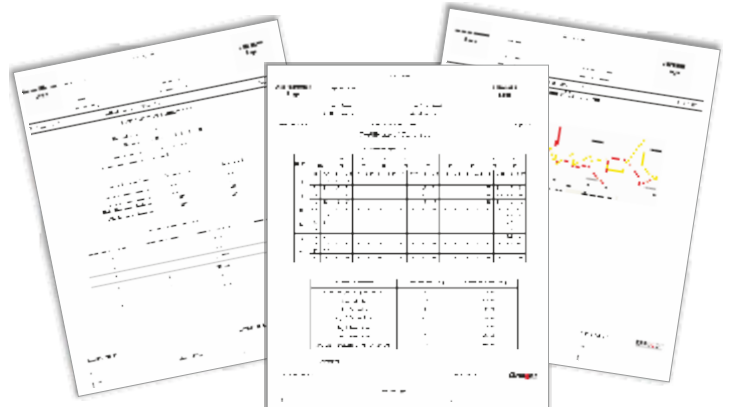

QMSOFT® Gauge Management Software

Octagon Length Measurement machines can also be offered with QMSOFT® Software package from L&W GmbH as an alternative option.

Features :

- All nominal sizes and tolerances for all related DIN or ISO standards as well as for ANSI standards, British standards and partly for Japanese, French or Korean standards are calculated by the program system.
- Gauge inspections will be started directly from the gauge management system and will be performed with inspection programs specially designed for the gauge type selected.
- Predefined inspection procedures does the following exactly the given rules and standards. So you do not need any preparation before starting a measurement.

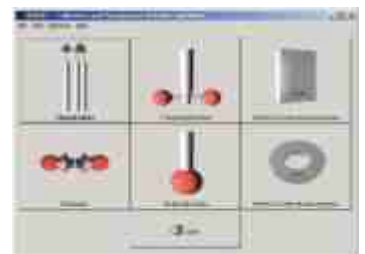

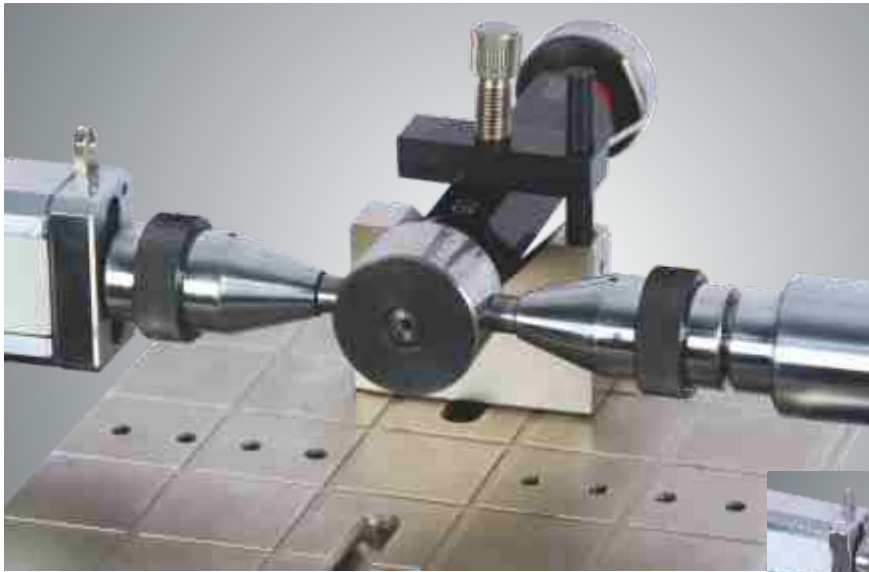

Plug Gauge (below 40 mm) measurement : Hold in Vee block holder

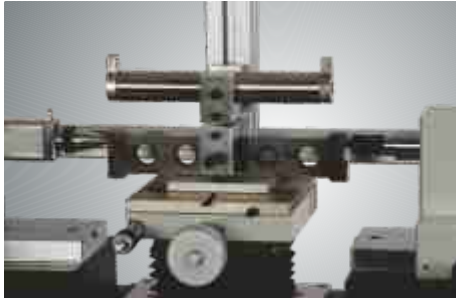

Plug Gauge (plate type) measurement : Hold on universal holder



Plug Gauge (above 40 mm) measurement : Hold on parallel blocks

External Measurements
Plain Plug Gauge / Cy. Standard Measurement :
By using a pair of Flat Anvils 8 mm dia.

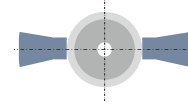

Measurement of cylinder diameter across flat anvils

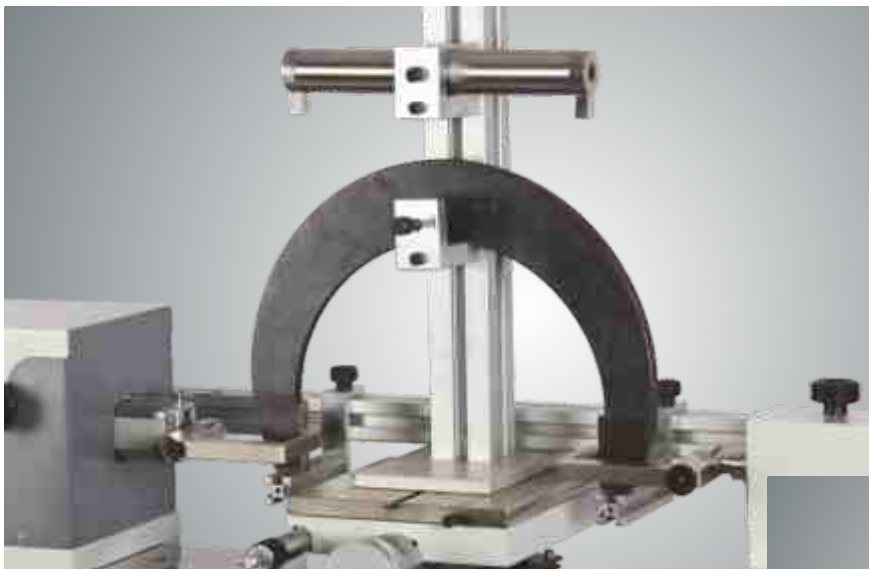

Snap Gauge C Type (above 300 mm) measurement : Hold on universal holder

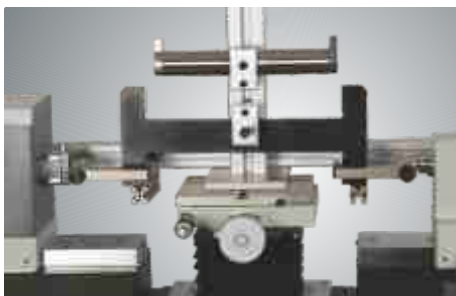

Snap Gauge (I type) measurement : Hold on universal holder

Internal Measurements
Snap Gauge Measurement :
By using fixed dual arms

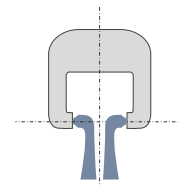

Measurement of gap by using spherical contact fixed dual arms



Snap Gauge (below 300 mm) measurement : Hold on snap gauge holding attachment

Internal Measurements

Ring Gauge Measurement :

By using Single Arm measuring attachment and / Or by using a pair of fixed dual arms.

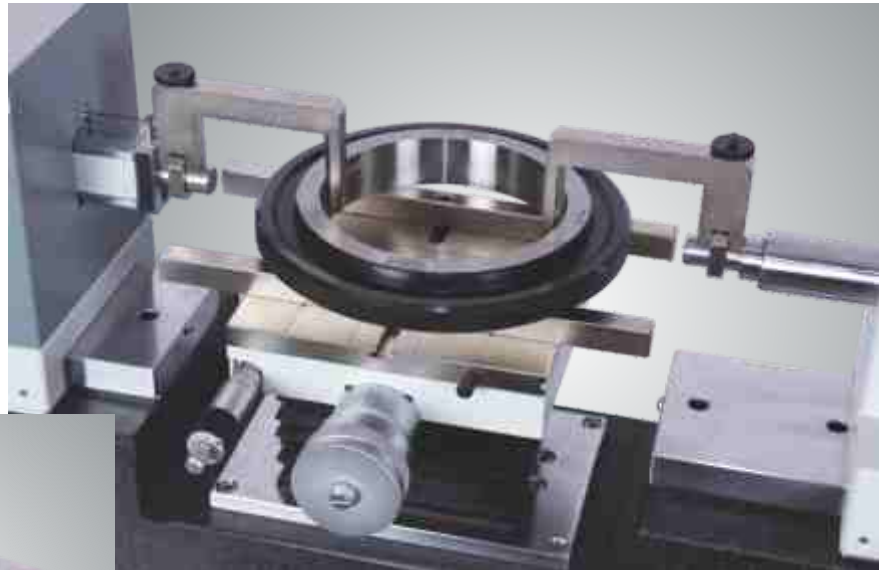

Plain ring diameter (above 10 mm) measurement : Using a pair of fixed arms



Plain ring diameter (above 2 mm) measurement : Using a Single Ruby Ball Stylus with bi-directional probing system of single arm measuring attachment

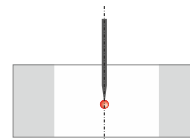

Measurement of internal diameter by using single arm measuring attachment with one axis bi-directional probing

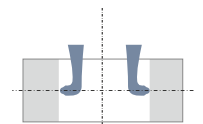

Measurement of internal diameter by using spherical contact fixed dual arms

External & Internal Taper Measurements :

Taper Plug Gauge / Taper Ring Gauge

By using Single Arm measuring attachment and / Or by a pair of Flat Anvils 8 mm dia.



Measurement of Taper angle and diameter by Precision cylindrical pin gauges.



Taper plug gauge measurement : By using cylindrical pin gauges (over pin measurement)

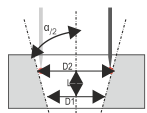

Measurement of Taper angle and diameter by using single arm measuring attachment with two axis bi-directional probing



Taper ring gauge measurement : Using a Single Ruby Ball Stylus with bi-directional probing system of single arm measuring attachment

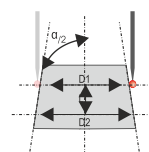

Measurement of Taper angle & diameter by using single arm measuring attachment with two axis bi-directional probing



Taper Plug gauge measurement : Using a Single Ruby Ball Stylus with bi-directional probing system of single arm measuring attachment



Cylindrical Thread Measurement (External)

Thread Plug Gauge Measurement :

By using three wire method : a pair of Flat Anvils 8 mm dia. & Thread measuring wires

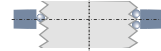

Three Wire Method For Measurement Of Effective Diameter (d2) Of External Thread

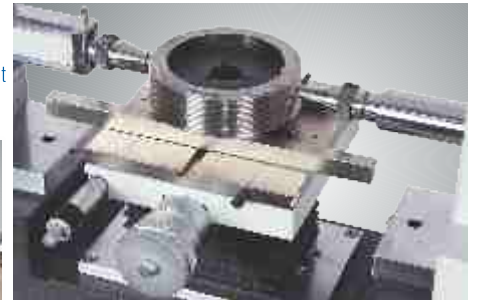

Cy. Thread Plug Gauge (below 100 mm) measurement : Hold between center table

Cy. Thread Plug Gauge Measurement of Effective diameter Below 40 mm : Hold in Vee block holder

Above 40 mm : Hold on parallel blocks

Cylindrical Thread Measurement (Internal)

Thread Ring Gauge Measurement :

Single Arm Measurement /Dual Arms Measurement

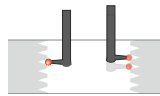

Thread ring gauge measurement of Effective Diameter (D2) by using flexible dual arm & spherical ruby styli

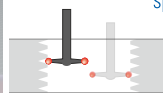

Thread ring gauge measurement of Effective Diameter (D2) by using single arm measurement attachment with single axis bi-directional probe & T-shape stylus

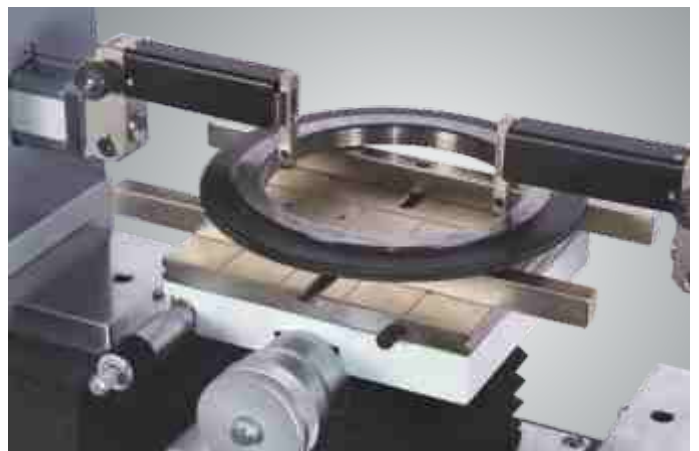

Cy. Measurement of effective diameter by using single arm measuring attachment & Precision Ruby T-Shape styli

Cy. Thread Ring gauge measurement of effective diameter by Precision Ruby ball styli and flexible dual measuring arms



Taper Thread Plug Gauge Measurement :

By using thread measuring wires and a pair of flat Anvils (8 mm) and / or by using Single Arm Measuring attachment with μ_{2d} probe (Two axis bi-directional probing) and T-shape Ruby stylus.



Taper Thread plug gauge measurement of d2 by using thread measuring wires and a pair of flat anvils



Taper thread plug gauge measurement of d2 by using single arm measurement attachment



Measurement of effective diameter by thread measuring wires

Measurement of effective diameter by T Shape Ruby Stylus Two axis bi-directional probing

Taper Thread Ring Gauge Measurement :

By using Single Arm Measuring attachment with μ_{2d} probe (Two axis bi-directional probing) and T-shape Ruby stylus.

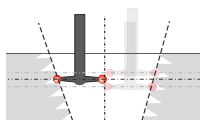

Taper thread ring gauge measurement of D2 by using single arm measurement attachment

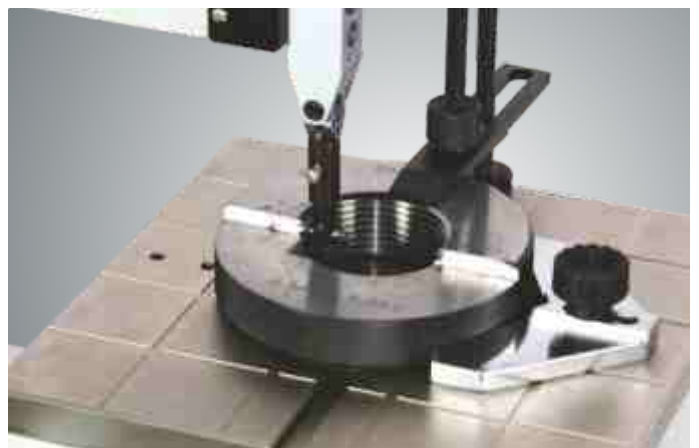

Measurement of effective diameter by T Shape Ruby Stylus Two axis bi-directional probing

Gear Measurement :
Spline Plug Gauge, Spline Ring Gauge measurement

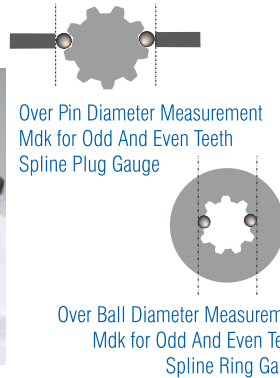

Spline ring gauge measurement by using fixed dual arm and precision spherical styli : Hold on floating table.

Spline plug gauge measurement by using cylindrical pins and a pair of flat anvils

Calibration / Inspection of measuring instruments :
Gauge Block, length Bar, setting standards measurements :
By using a pair of spherical Anvils



Gauge block /
Length Bar measurement
by using a pair of ball anvils

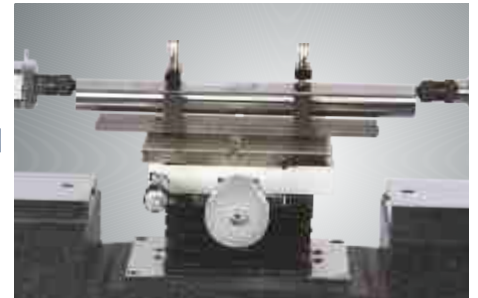

Length bar measurement : Hold on table by using holding attachment

Calibration / Inspection of measuring instruments :
Dial Indicators, Dial Test Indicators, Bore Gauge



Dial Indicator Calibration : Hold on table by using holding attachment



Bore Gauge Calibration : Hold on table by using holding attachment and machine spindle drive unit.



Dial Test Indicator Calibration : Hold on table by using holding attachment

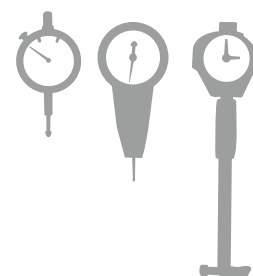

Universal Length Measuring System For Calibration Metrology

Calibration / Inspection of measuring instruments :
External Micrometers / Internal Micrometers, Calipers.

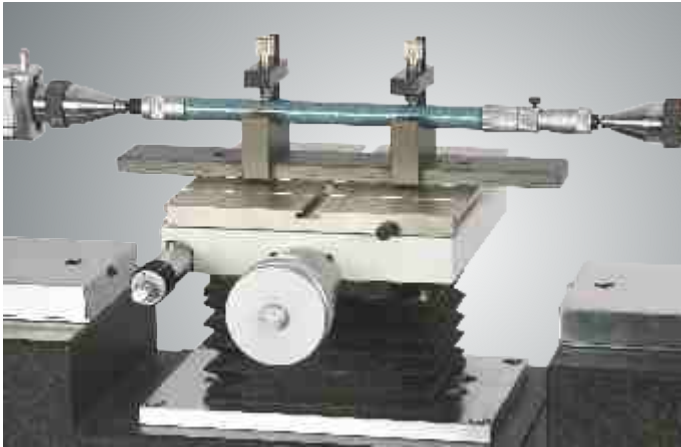

Internal Micrometer (2 point) Calibration : Hold on table by using holding attachment



Internal micrometer (3 point) Calibration : By using V reference standards and Flat anvil.

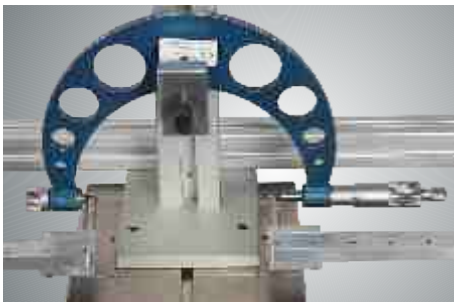
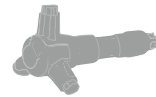

External Micrometer (above 150 mm) Calibration :
Hold on universal holder.



External Micrometer (Below 150 mm) Calibration :
Hold on table by using C clamp



Caliper Calibration : Hold on universal holder



Octagon[®]
PRECISION

Octagon Precision (India) Pvt. Ltd.

Regd. Off. : 3 / 19 Girija Society, M.I.T. College Road, Kothrud, Pune 411029. India
Plant : S.No. 15 A/2, J7 & J8, GKD Industrial Estate, Nandedgaon, Sinhgad Road, Pune 411041.
Tel. : + 91 - 20 - 3231 8697
Fax : + 91 - 20 - 2543 9282
E-mail : sales@octagon.co.in
Web : www.octagon.co.in