



Instrument
Division

Programmable Multifunction Transducer (PMT-9)

The PMT-9 Multifunction Programmable Transducer measures the several variables of an electric power system and processes them to produce 4 analog output signals. 2 digital output signals are available for signaling the limits. The limits of the outputs can be set by individual measurand or logically combine up to three measurand. The principle of measuring is Dedicated DSP Controller for best calculation of RMS values and Power.

The PMT-9 is equipped with USB serial port interface through which using the corresponding software one can connect, program, or access and execute useful ancillary functions. The ancillary functions include a power system check, provision for displaying the measured variably on a PC monitor, the simulation of the outputs for test purposes.

The PMT-9 is also equipped with a RS 485 bus interface (MODBUS®). The RS 485 interface enables the user to determine the number of variables to be supervised (up to the maximum available). The levels of all internal power/ energy meters that have been configured can also be viewed. Provision is made for programming the PMT-9 via the bus. A standard EIA 485 interface can be used, but there is no dummy

Features

Simultaneous measurement of several variables of a heavy-current power system / Full supervision of an asymmetrically loaded four wire power system, rated current 1 to 6 A, rated voltage 57 to 400V (phase-to-neutral) or 100 to 693 V (phase-to-phase) For all heavy-current power system variables

- Fully Programmable CT and PT Ratio.
- 4 analogue outputs
- Digital Outputs
- Conversion of a **current** to a **voltage** output or **vice versa** is also possible without any hardware change.
- Input voltage up to 693 V (phase-to-phase)
- Universal analogue outputs (programmable)
- High accuracy: U/I 0.2% and P 0.25% (under reference conditions)
- Windows software with password protection for programming, data analysis, power system status simulation, acquisition of meter data and making settings
- AC/DC power supply / Universal
- Compact in size.
- Low Weight
- Provision for either snapping the transducer onto top-hat rails or securing it with screws to a wall or panel
- Rated Burden Resistor up to 1KΩ for 20mA.

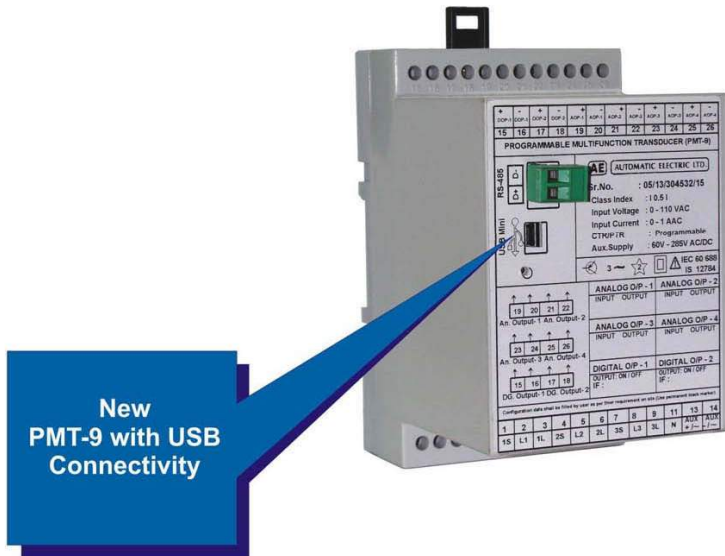

Functional Block Diagram:

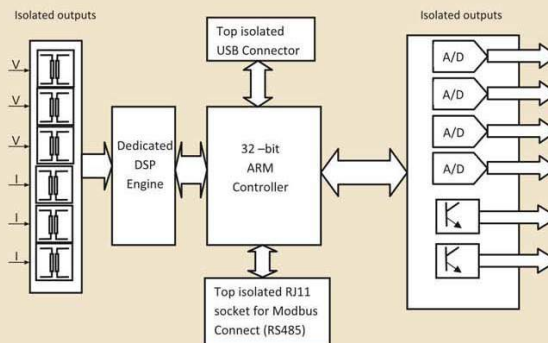

Applicable Standards :

- | | |
|----------------------|---|
| EN 60688(2012) | : Electrical measuring transducers for converting AC electrical variables into analog and digital signals |
| IS 12784 | : Electrical measuring transducers for converting ac Electrical Quantities into dc Electrical quantities - specification. |
| IEC 1010 or EN 61010 | : Safety regulations for electrical measuring, control and laboratory equipment |
| IEC 61326 - 1 | : Electromagnetic compatibility for Electrical Equipment for measurement, control and |



Instrument
Division

Programmable Multifunction Transducer (PMT-9)

Symbols\Abbreviations Used

Symbols Meaning

X	Measured variable
X0	Lower limit of the measured variable
X1	Break point of the measured variable
X2	Upper limit of the measured variable
Y	Output variable
Y0	Lower limit of the output variable
Y1	Break point of the output variable
Y2	Upper limit of the output variable
U	Input voltage
Ur	Rated value of the input voltage
U 12	Phase-to-phase voltage L1 – L2
U 23	Phase-to-phase voltage L2 – L3
U 31	Phase-to-phase voltage L3 – L1
U1N	Phase-to-neutral voltage L1 – N
U2N	Phase-to-neutral voltage L2 – N
U3N	Phase-to-neutral voltage L3 – N
UM	Average value of the voltages (U1N+U2N+U3N) / 3
I	Input current
I1	AC current L1
I2	AC current L2
I3	AC current L3
Ir	Rated value of the input current
IM	Average value of the currents (I1 + I2 + I3) / 3
IMS	Average value of the currents and sign of the active power (P)
Ø	Phase-shift between current and voltage
F	Frequency of the input variable
Fn	Rated frequency
P	Active power of the system $P = P1 + P2 + P3$
P1	Active power phase 1 (phase-to-neutral L1 – N)
P2	Active power phase 2 (phase-to-neutral L2 – N)
P3	Active power phase 3 (phase-to-neutral L3 – N)
Q	Reactive power of the system $Q = Q1 + Q2 + Q3$
Q1	Reactive power phase 1 (phase-to-neutral L1 – N)
Q2	Reactive power phase 2 (phase-to-neutral L2 – N)
Q3	Reactive power phase 3 (phase-to-neutral L3 – N)
S	Apparent power of the system ; $S = \sqrt{(I^2 + I^2 + I^2) + \sqrt{(V^2 + V^2 + V^2)}}$
S1	Apparent power phase 1 (phase-to-neutral L1 – N)
S2	Apparent power phase 2 (phase-to-neutral L2 – N)
S3	Apparent power phase 3 (phase-to-neutral L3 – N)
Sr	Rated value of the apparent power of the system
PF	Active power factor $\cos \varnothing = P/S$
PF1	Active power factor phase 1 $\cos \varnothing_1 = P1/S1$
PF2	Active power factor phase 2 $\cos \varnothing_2 = P2/S2$
PF3	Active power factor phase 3 $\cos \varnothing_3 = P3/S3$
QF	Reactive power factor $\sin \varnothing = Q/S$
QF1	Reactive power factor phase 1 $\sin \varnothing_1 = Q1/S1$
QF2	Reactive power factor phase 2 $\sin \varnothing_2 = Q2/S2$
QF3	Reactive power factor phase 3 $\sin \varnothing_3 = Q3/S3$
LF	Power factor of the system $LF = \text{sgn}Q \cdot (1 - I\text{-PFI})$
LF1	Power factor phase 1 $LF1 = \text{sgn}Q1 \cdot (1 - I\text{-PFI})$
LF2	Power factor phase 2 $LF2 = \text{sgn}Q2 \cdot (1 - I\text{-PFI})$
LF3	Power factor phase 3 $LF3 = \text{sgn}Q3 \cdot (1 - I\text{-PFI})$
c	Factor for the intrinsic error
R	Output load
Rn	Rated burden
H	Power supply
Hn	Rated value of the power supply
CT	c.t. ratio
VT	v.t. ratio

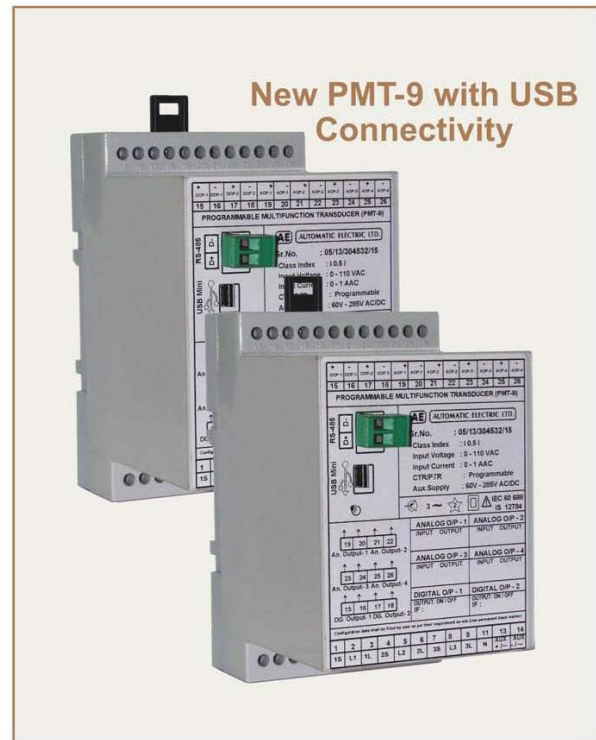

New PMT-9 with USB
Connectivity



Programmable Multifunction Transducer (PMT-9)

Instrument Division

Technical data:

Inputs

Input variables : U, U1N, U2N, U3N, U12, U23, U31, UM, I, I1, I2, I3, IM, IMS, P, P1, P2, P3, Q, Q1, Q2, Q3, S, S1, S2, S3, PF, PF1, PF2, PF3, QF, QF1, QF2, QF3, LF, LF1, LF2, LF3

Measuring ranges

Measurand	Initial Value	Final Value
U	$0 \leq X0 \leq 0.9 * X2$	$0.8 * Ur \leq X2 \leq 1.2 * Ur$
I	$0 \leq X0 \leq 0.8 * X2$	$0.5 * Ir \leq X2 \leq 1.5 * Ir$
P, Q, S	$- X2 \leq X0 \leq 0.8 * X2$	$0.3 \leq X2 / Sr \leq 1.5$
PF, QF	$- 1 \leq X0 \leq (X2 - 0.5)$	$0 \leq X2 \leq 1$
F	$45\text{Hz} \leq X0 \leq (X2 - 2)$	$(X0 + 2) \leq X2 \leq 65\text{Hz}$

Waveform : Sinusoidal
 Rated frequency : 50...($\pm 10\%$) Hz

Continuous thermal ratings of inputs:

Current circuit : 8 A
 Voltage circuit : 480 V single-phase AC systems
 600 V three-phase systems

Short-time thermal rating of inputs

Input variable	Number of inputs	Duration of overload	Interval between Two overloads
Current circuit			
10 A	10	10s	10s.
50 A	5	3s	5min.
Voltage circuit			
1 \emptyset AC system 600 V (L-N)	10	10s	10s
3 \emptyset AC system 1200 V (L-L)	10	10s	10s

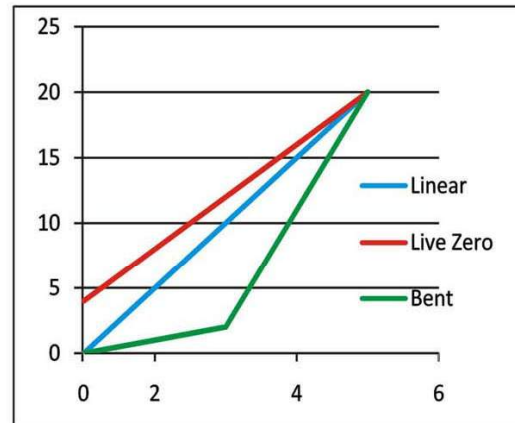

Outputs :

4 analog outputs following the corresponding process variable programmed through the software. These signals can be set in various patterns like Linear, live zero, bent. The outputs A, B, C and D may be either short or open-circuited. They are electrically insulated from each other and from all other circuits (floating). All the full-scale output values can be reduced subsequently using the programming software, subjective a supplementary error results. Conversion of a current to a voltage output or vice versa is also possible without any hardware change.

Output signal	Initial value X0	Final value X2
DC current (Linear) (Live zero)	$Y0 = 0$ $0 \leq Y0 \leq 0.2 * Y2$	$Y2 = 20 \text{ mA}$ $1 \text{ mA} \leq Y2 \leq 20 \text{ mA}$
DC voltage	$0 \leq Y0 \leq 0.2 * Y2$	$1 \text{ V} \leq Y2 \leq 10 \text{ V}$
Bent Characteristics (applicable to both Voltage and Current Output) $(X0 + 0.015 * X2) \leq X1 \leq 0.985 * X2$ $Y0 \leq Y1 \leq Y2$		

Digital outputs, pulse outputs, limit outputs

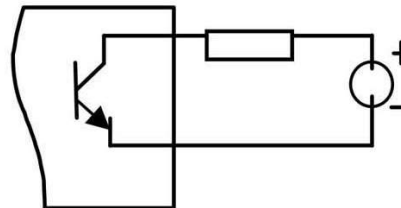

Type of contact : Open collector
 Pulse duration : $\geq 80 \text{ ms}$
 Interval : $\geq 80 \text{ ms}$
 Power supply : 8 ... 40 V
 Output current : ON 10 ... 27 mA
 OFF $\leq 2 \text{ mA}$



Programmable Multifunction Transducer (PMT-9)

Instrument Division

Electrical connections

Connection	Terminal No.	Connection	Terminal No.
V _R	2	(ANALOG O/P)1+	19
V _Y	5	(ANALOG O/P)1-	20
V _B	8	(ANALOG O/P)2+	21
N	11	(ANALOG O/P)2-	22
IR	1	(ANALOG O/P)3+	23
IR'	3	(ANALOG O/P)3-	24
I _Y	4	(ANALOG O/P)4+	25
I _{Y'}	6	(ANALOG O/P)4-	26
IB	7	(DIGITAL O/P)1+	15
IB'	9	(DIGITAL O/P)1-	16
AUX	13	(DIGITAL O/P)2+	17
AUX	14	(DIGITAL O/P)2-	18

Environmental

Working Temperature	: -5° to +55° C
Storage	: -10 to +70 deg c
Relative Humidity	: 0 to 95% non condensing
Vibration / Shock	: 12 g, 10-55-10 Hz
Weight	: 408 gm.

Safety

Protection Class	: Class II
IP Rating	: IP20
Over Voltage Cat	: Cat III
Insulation Test Vs Earth	: 500V
Surge Test	: 5KV, 12/50us, 5WS
HV Test	: I/p to O/p isolation 4KV o/p to o/p isolation 500 V 2KV
Communication Interface	: (USB / RS485) to all circuit 2KV

MODBUS (Data Communication)

BUS Interface	: RS485
Terminal	: Plug in Type Phoenix connector
Max. Distance	: 1200Mtr.
No. Of Bus Stations	: Up to 248 including Master.
Dummy load	: Not required

USB (Transducer Configuration)

USB Details	: Data communications to PC via USB Mini Type B at IRS 200 baud rate for configuration of PMT 9
-------------	--

USB Connector :

USB Female B-Type Connector. Software CD containing Driver and Windows based Software for Configuration of PMT-9 is supplied along with the Box Pack.

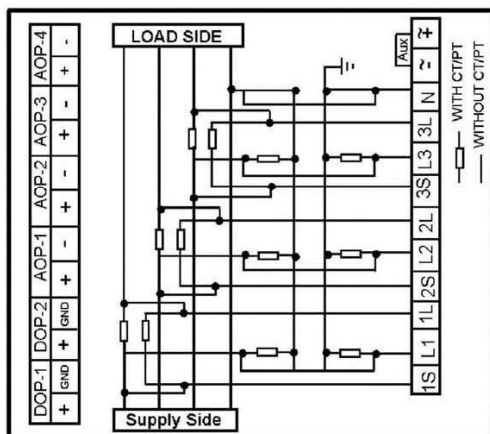

Mechanical Dimensions

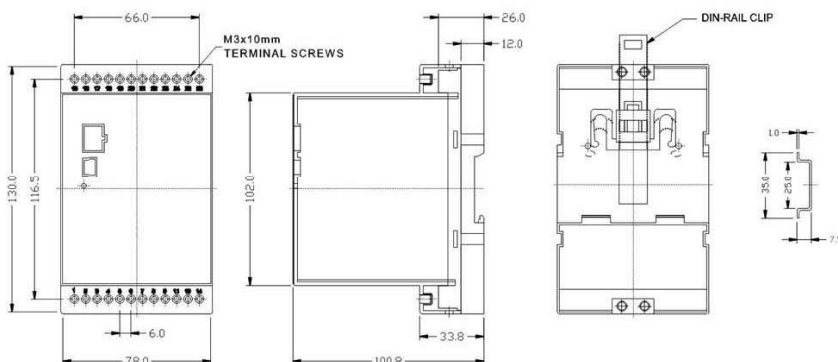

AE Automatic Electric Ltd.

Registered Office & Marketing Division:
Rectifier House, 570, Naigaum Cross Road, Wadala, Mumbai 400 031, India
Tel.: 91-22-24131849 / 24151794 / 24162261, Fax: 91-22-24112582
E-mail :sales@aelindia.com, For Technical know-how : development@aelindia.com



www.aelindia.com