

ARCHITECTURAL

DIE NO. 3X1GM



SCALE 1 : 1

WT. RANGE 2.800-3.000 KG./12'

COMMERCIAL NEW

DIE NO. 3X1 HANDLE



SCALE 1 : 1

WT. 2.625 KG./12'

DIE NO. 1850 HANDLE

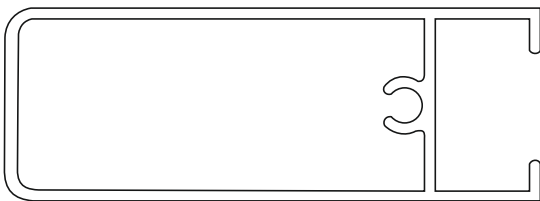

SCALE 1 : 1

WT. 1.43 KG./12'

DIE NO. 1850 INTERLOCK

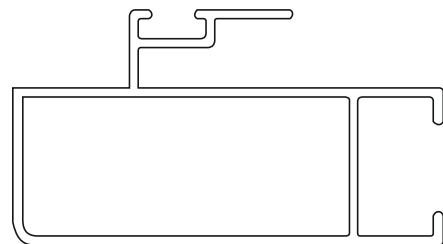

SCALE 1 : 1

WT. 1.68 KG./12'

DIE NO. 1860 HANDLE

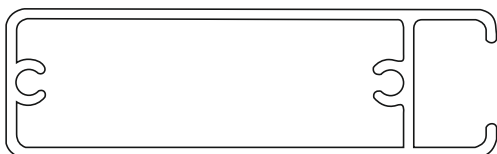

SCALE 1 : 1

WT. 2.01 KG./12'

DIE NO. 1860 INTERLOCK

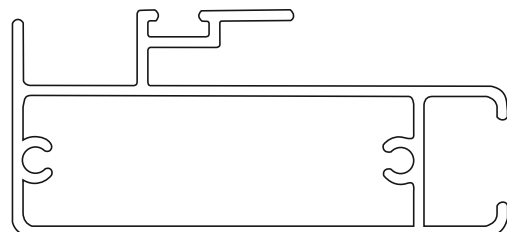

SCALE 1 : 1

WT. 2.5 KG./12'

SELECTIONS NOT TO BE SCALED

ALL DIMENSIONS ARE IN MM

ARCHITECTURAL

DIE NO. 2565 HANDLE

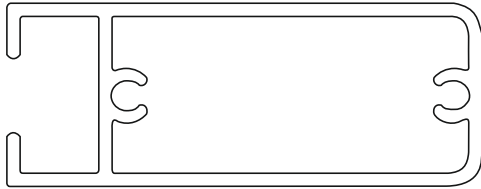

SCALE 1 : 1

WT. 3.22 KG./12'

COMMERCIAL NEW

DIE NO. 2565 INTERLOCK

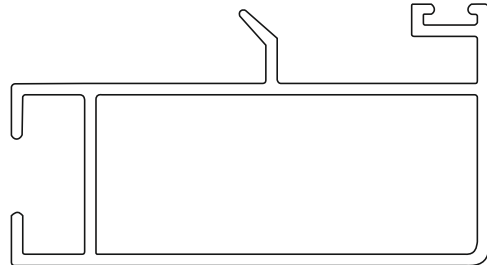

SCALE 1 : 1

WT. 3.050 KG./12'

DIE NO. 2575 BOTTOM

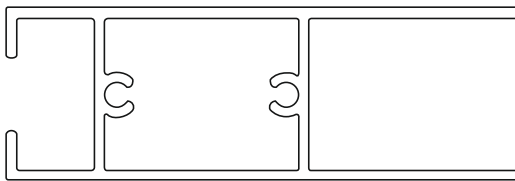

SCALE 1 : 1

WT. RANGE 2.900-3.300 KG./12'

DIE NO. 2575 HANDLE

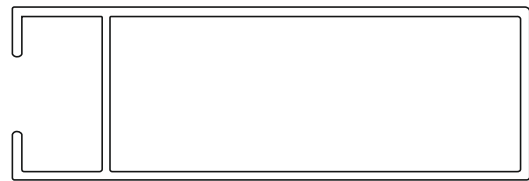

SCALE 1 : 1

WT. RANGE 2.300-2.700 KG./12'

DIE NO. 2575 INTERLOCK1

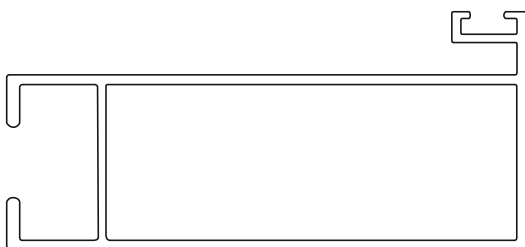

SCALE 1 : 1

WT. RANGE 2.780-3.200 KG./12'

DIE NO. 2575 INTERLOCK

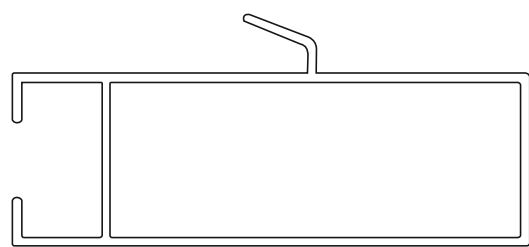

SCALE 1 : 1

WT. RANGE 2.500-2.800 KG./12'

SELECTIONS NOT TO BE SCALED

ALL DIMENSIONS ARE IN MM

ARCHITECTURAL

DIE NO. 2580 TOP BOTTOM

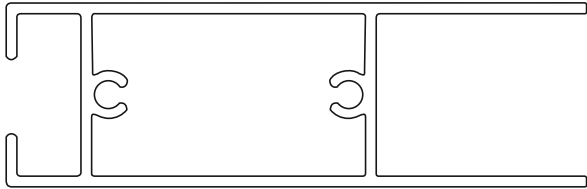

SCALE 1 : 1

WT. 3.050 KG./12'

COMMERCIAL NEW

DIE NO. 8050 INTERLOCK 2

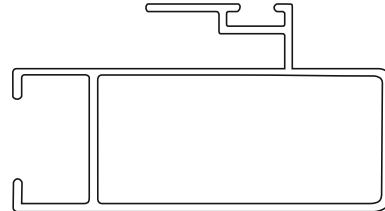

SCALE 1 : 1

WT. RANGE 1.880-2.100 KG./12'

DIE NO. 8050 INTERLOCK

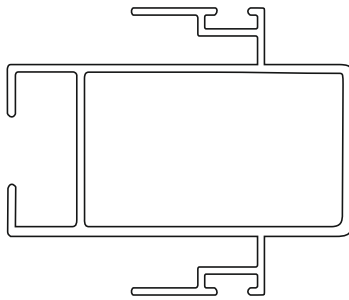

SCALE 1 : 1

WT. RANGE 2.200-2.500 KG./12'

DOMELL PATTI

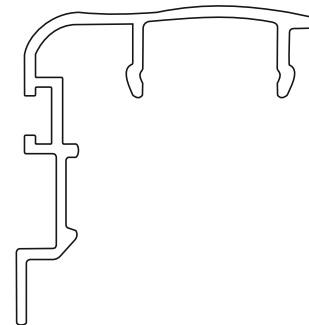

SCALE 1 : 1

WT. 1.090 KG./12'

DOMELL LOCK

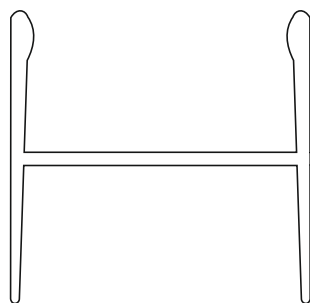

SCALE 1 : 1

WT. 0.730 KG./12'

DOMELL SECTION 1

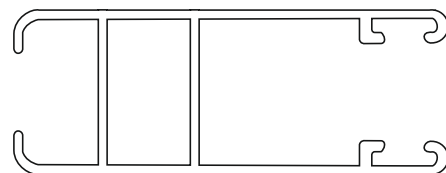

SCALE 1 : 1

WT. RANGE 2.000-2.400 KG./12'

SELECTIONS NOT TO BE SCALED

ALL DIMENSIONS ARE IN MM

ARCHITECTURAL

DOMELL SECTION 2

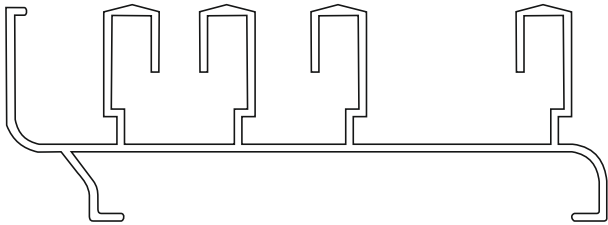

SCALE 1 : 1

WT. RANGE 3.000-3.400 KG./12'

COMMERCIAL NEW

DOMELL SECTION 3

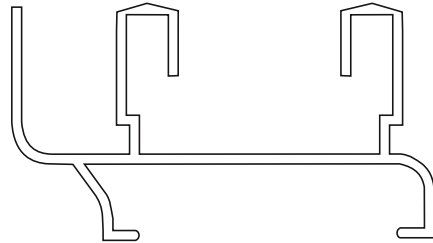

SCALE 1 : 1

WT. RANGE 2.180-2.500 KG./12'

DOMELL SHUTTER

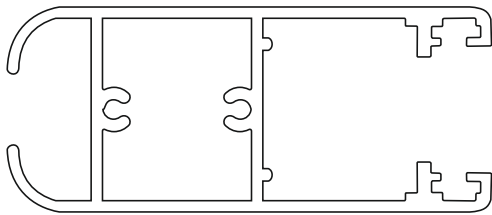

SCALE 1 : 1

WT. 3.460 KG./12'

DIE NO. RT5020

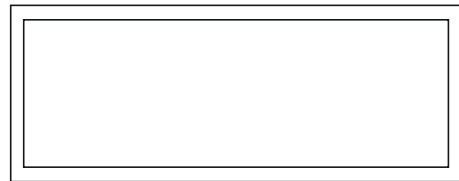

SCALE 1 : 1

WT. RANGE 2.000-2.500 KG./12'

DIE NO. RT7512

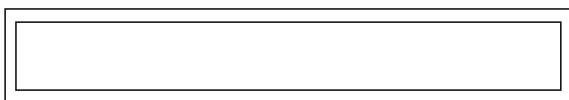

SCALE 1 : 1

WT. RANGE 2.500-3.000 KG./12'

DIE NO. RT10012

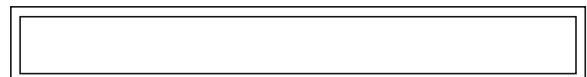

SCALE 1 : 1

WT. RANGE 3.600-4.000 KG./12'

SELECTIONS NOT TO BE SCALED

ALL DIMENSIONS ARE IN MM

ARCHITECTURAL

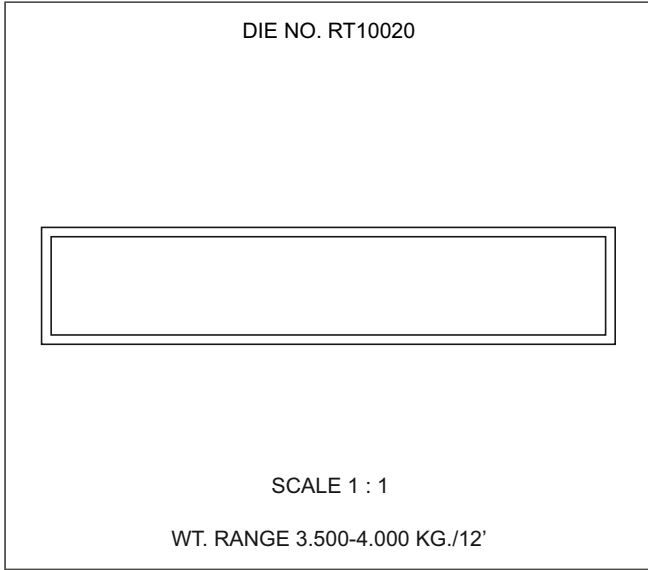

COMMERCIAL NEW

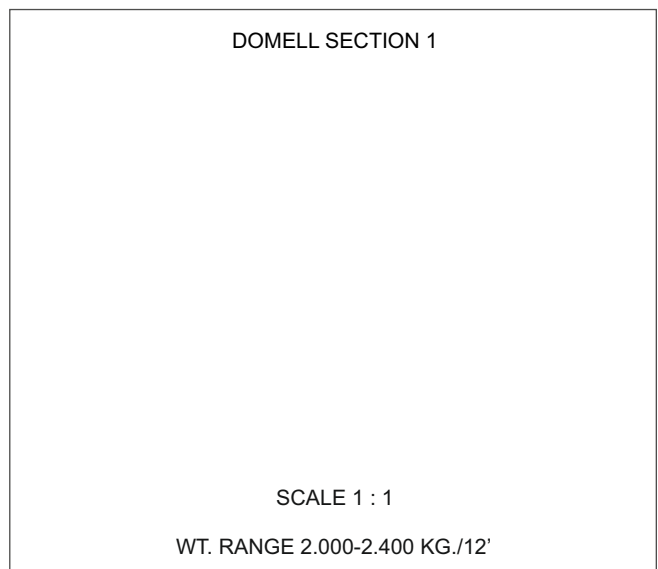
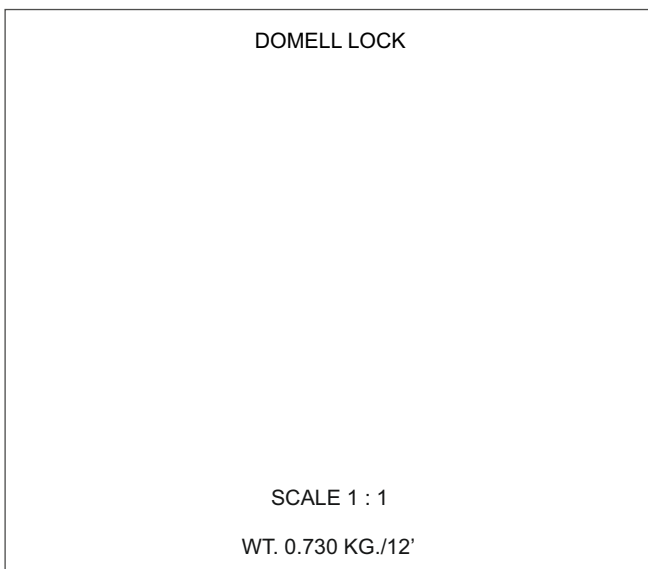
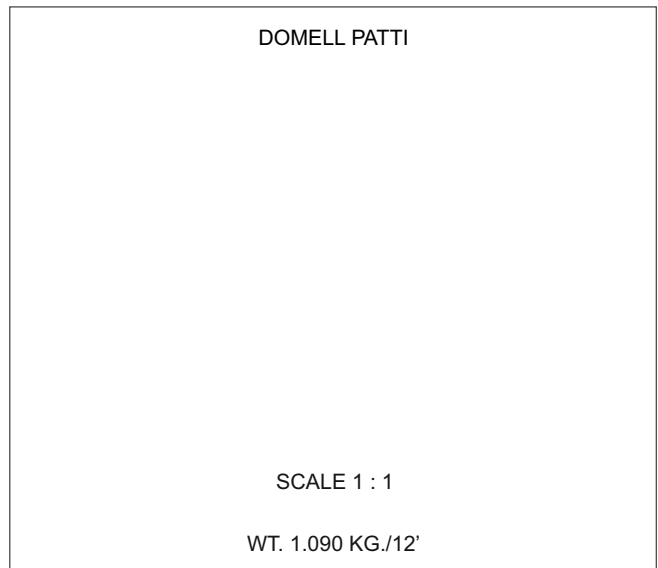
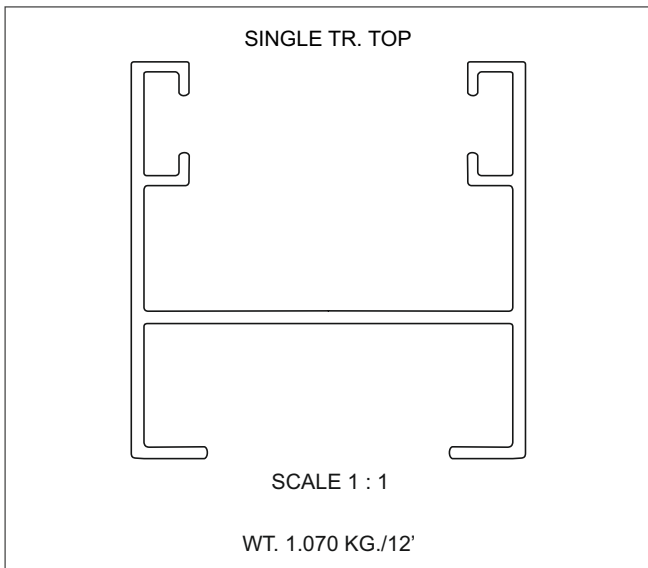
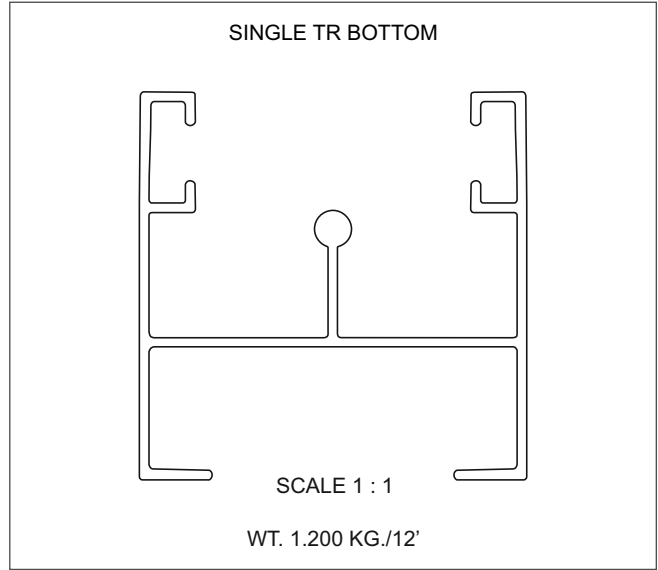

SELECTIONS NOT TO BE SCALED

ALL DIMENSIONS ARE IN MM