



SIAT

M. J. MAILLIS GROUP

S26 Semi-Automatic Carton Sealer

Strong lifting structure with A-frame



Bottom side application tape



Perfect control by side guides



for more details:



S26

S26 represents the semi-automatic machine with manual adjustment designed for king size boxes.

Easy to use and simple to adjust, this machine enables to start the production in few minutes time.

Thanks to the top and bottom drive belts and the K12R or K11R taping units, they allow the perfect sealing of the box.

The strong dual mast structure with A-frame of the S26 is ready to process big size cartons, always keeping the high level of reliability of SIAT machinery.

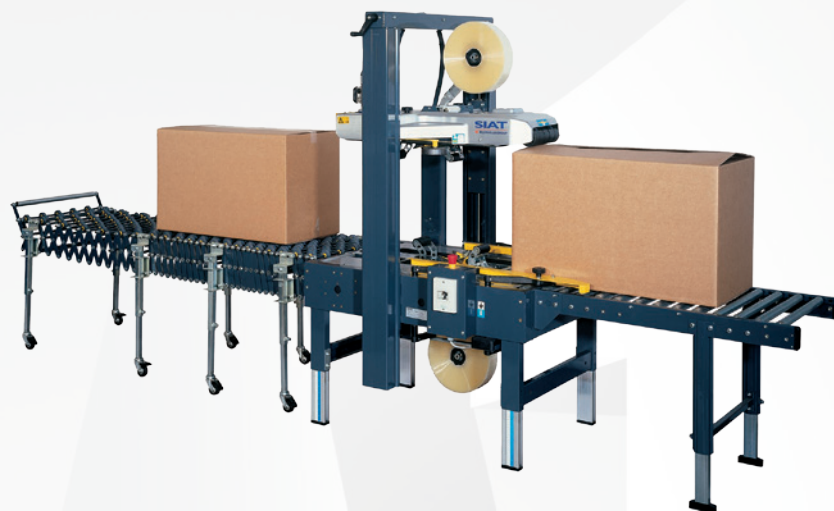

other languages: www.siat.com



> **Machine dimensions**
Dimensioni macchina
Machinemessungen
Dimensions machine
Dimensiones de máquina

| Size / Weighth packaging | | | LxWxH |
|--------------------------|-----|-----|-------------|
| > S26 | 185 | 220 | 133x110x175 |

> S26

| | Min. | Max |
|-------|----------|----------|
| L | 1080 | - |
| W | 890 | - |
| H | 1555 | 2125 |
| cbh | 480 | 820 |
| AS 77 | cbh +110 | cbh +110 |
| AS 80 | cbh +160 | cbh +160 |

> S26

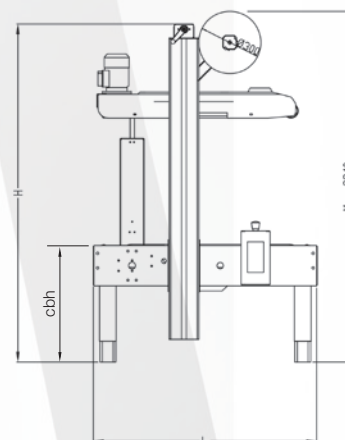

> **Box dimensions**
Dimensioni delle scatole
Kartonabmessungen
Dimensions des boîtes
Dimensiones de cajas

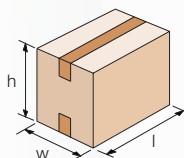

* With top side pressure rollers (minimum width manageable 180mm).
Upper guides required in case of width box less than 180mm (optional).

> S26

| | K11R std. / K12R on demand | |
|----|----------------------------|-----|
| | Min. | Max |
| l | 150 | ∞ |
| w* | 170 / 140 | 650 |
| h | 100 | 950 |

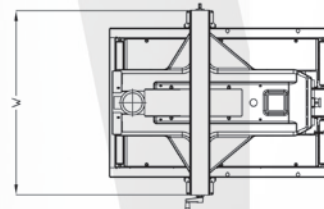

> **Production capacity**
Capacità di produzione
Produktionskapazität
Capacité de production
Capacidad de producción

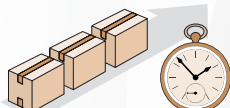

| > S26 | Bph |
|-----------|------|
| Max pcs.* | 1200 |

* Always based on shorter manageable box

> **Standard voltage**
Voltaggio standard
Standardspannung
Tension standard
Voltaje estándar

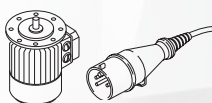

> S26

| 380/415V - 50Hz - 3Ph | |
|-----------------------|----------|
| Amps | 1,08 |
| Power kW | 0,26 |
| Phase | 3Ph + PE |

> **Taping units**
Unità nastranti
Verschliesseinheiten
Unités enrubanneuses
Unidades de precinto

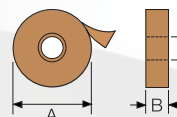

| | K11R/ K12R | |
|---|------------|--|
| | mm | |
| A | 410 Max | |
| B | 50 / 75 | |
| C | 76 | |

> **Optionals**
Accessori
Zubehör
Accessories
Accesorios

> **AS80**
Higher legs
Set gambe più alte
Höhere Stützen
Pieds plus hauts
Patas más altas

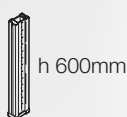

> **AS77**
Casters
Set ruote
Rädchen
Roulettes
Ruedas

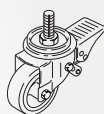

> **RG**
Roller conveyor
Piani a rulli
Rollenbahnen
Plans à rouleaux
Rodillos libres



> **GTL - GTR**
Extendable conveyor
Rulliera estensibile
Ausziehbare rollenbahnen
Convoyeur extensible
Rodillos extensibles

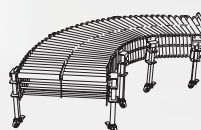

> **K-125 / K-250**
Inkjet printer
Stampante ad inchiostro
Tintenstrahldrucker
Marqueur à jet d'encre
Impresora de inyección de tinta

