

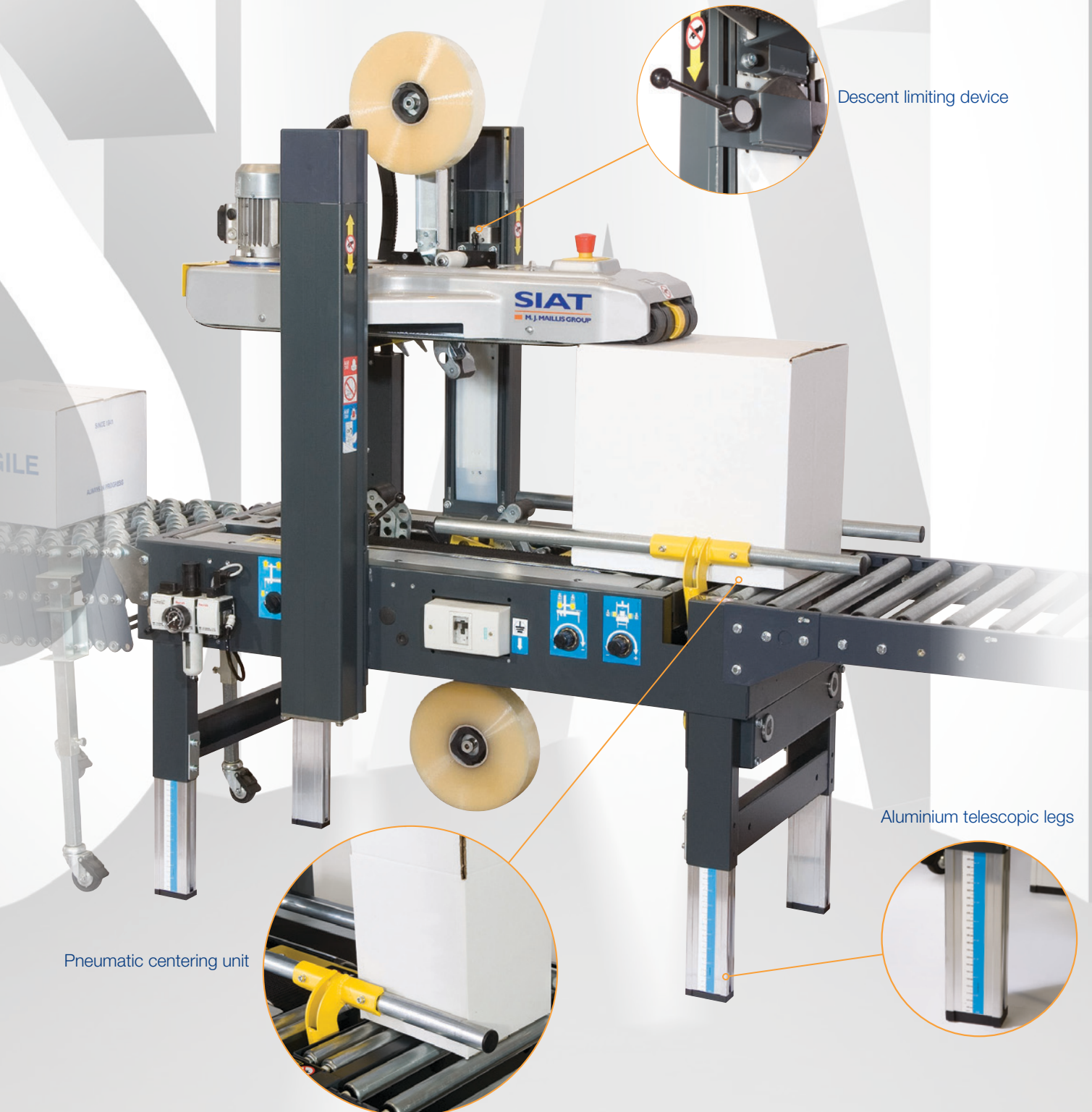

# SIAT

M. J. MAILLIS GROUP

## SR46 Semi Automatic Carton Sealers



Descent limiting device

Aluminium telescopic legs

Pneumatic centering unit



for more details:



SR46

SR46 is a semi-automatic sealing machine with random adjustment. The machine consists of a metal structure painted with epossidic paint and columns in aluminium. The sliding plan of boxes is made up of galvanized rolls and stainless steel plate.

**Working Cycle:** the operator folds the top flaps and moves box forward in the machine until it is taken away by drive belts. The case sealer adjusts itself according to the box size and proceeds with the top and bottom sealing. The machine has been designed in compliance with CE regulations.



other languages: [www.siat.com](http://www.siat.com)



> Taping units  
Unità nastranti  
Verschliesseinheiten  
Unités enrubanneuses  
Unidades de precinto

> K12R  
TOP VERSION



> K12R  
BOTTOM VERSION



> Machine dimensions  
Dimensioni macchina  
Machinemessungen  
Dimensions machine  
Dimensiones de máquina

Size / Weighth packaging			LxWxH 
> SR46	180	225	135x105x155

> SR46

	Min.	Max
L	1395	-
W	890	-
H	1560	1900
cbh	480	800
AS 77	cbh +110	cbh +110
AS 80	cbh +160	cbh +160

> SR46

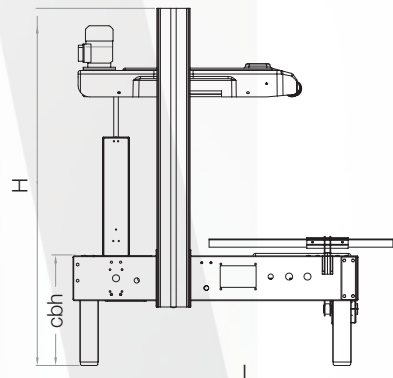

> Box dimensions  
Dimensioni delle scatole  
Kartonabmessungen  
Dimensions des boîtes  
Dimensiones de cajas

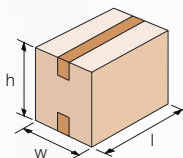

> SR46

	K12R	
	Min.	Max
l	150	∞
w	170	650
h	100	650

> Production capacity  
Capacità di produzione  
Produktionskapazität  
Capacité de production  
Capacidad de producción

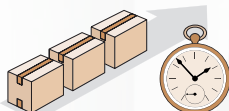

> SR46	Bph
Max pcs.*	900

\* Always based on shorter manageable box

> Air consumption  
Consumo aria  
Druckluftverbrauch  
Consumation air comprimé  
Consumo de arie

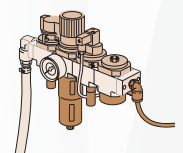

> SR46	NL.
Cycle	9

from 5,5 bar to 7 bar

> Standard voltage  
Votaggio standard  
Standardspannung  
Tension standard  
Voltaje estándar

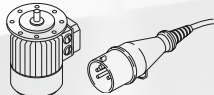

> SR46

380/400V - 50Hz - 3F	
440V - 60Hz - 3F	
Amps	1,08
Power kW	0,26
Phase	3Ph + N + PE

> Taping units  
Unità nastranti  
Verschliesseinheiten  
Unités enrubanneuses  
Unidades de precinto

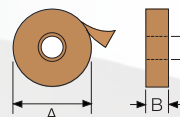

	K12R mm
A	410 Max
B	75
C	76

> Optionals  
Accessori  
Zubehör  
Accessories  
Accessorios

> AS80  
Higher legs  
Set gambe più alte  
Höhere Stützen  
Pieds plus hauts  
Patas más altas

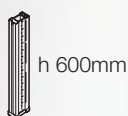

> AS77  
Casters  
Set ruote  
Rädchen  
Roulettes  
Ruedas

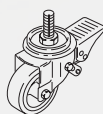

> RG  
Roller conveyor  
Piani a rulli  
Rollenbahnen  
Plans à rouleaux  
Rodillos libres



> GTL - GTR  
Extendable conveyor  
Rulliera estensibile  
Ausziehbare rollenbahnen  
Convoyeur extensible  
Rodillos extensibles

