

# Automatic Bag Filling System

Widely used for granule packing



# Bagging System

PAB-25K is an automatic weigh filler, its self-optimizing controls can be precisely configured to your specific material flow, speed & accuracy requirements

## Highlights

- ⊕ Specially designed for granular products like Rice, Pulses, Plastic Granules, Animal Feed, Maize, Soybeans, Seeds etc
- ⊕ Equipped with self optimizing intelligent program for high speed operation
- ⊕ Can be easily mounted directly below the storage
- ⊕ Models available in 5~25 kg, 10~50 kg, 10~100 kg
- ⊕ Accuracy range +/- 10gm for 25kg, +/- 20gm for 50kg , +/- 50gm for 100kg
- ⊕ Speed upto 14 Bags per minute for 25kg.





# Auto Filler

## Industrial Design

Special design for industrial application with high speed and accuracy



## Modular Design

Standard flange interface for easy and fast installation

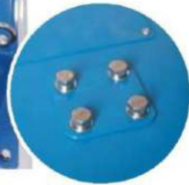
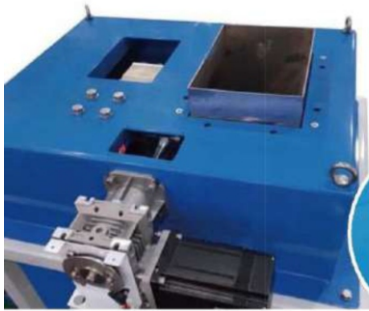

**Load Cell Installation Location**



**Control Indicator**

- ⊕ The food contacting material are all made of SS304 stainless steel and can be used for food packaging such as rice, soybeans, corn, grains, mung beans, etc.

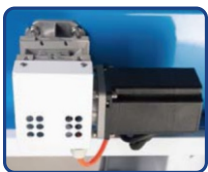
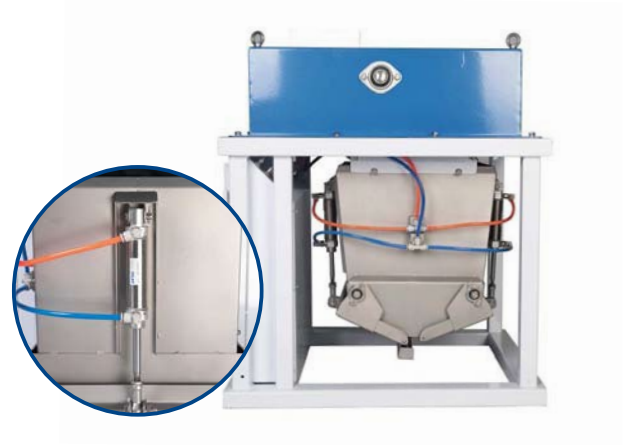

### Stepper Motor

For feeding control achieves intelligent auto adjustment fast and accurately



### USB

Embedded USB for exporting data conveniently and system upgrading

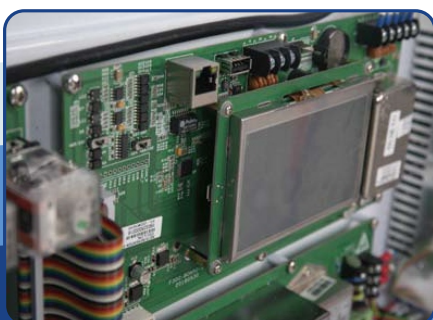

- ⊕ Prompt R&D division is making software system perfectly customized so packaging time is faster, accurate and smarter
- ⊕ Dual serial port RS232/RS485
- ⊕ Modbus TCP/IP
- ⊕ 4G/5G Communication (Optional)

# User-Friendly design

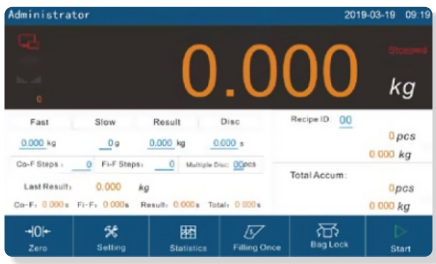

10-inch touch screen, real-time display of current status, detection of weight, recipe information, fast/ slow feeding and other key data.

⊙ Parameter interface optimization and upgrade.

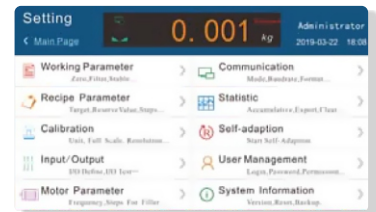

⊙ Observing data changes when setting parameters, which is simultaneous and intuitive.

⊙ Calibration according to different materials with step hints to make the field calibration more convenient.



# Well-organized data management

Motor parameters: an interface can simultaneously display the motor status and parameters which is easy to debug

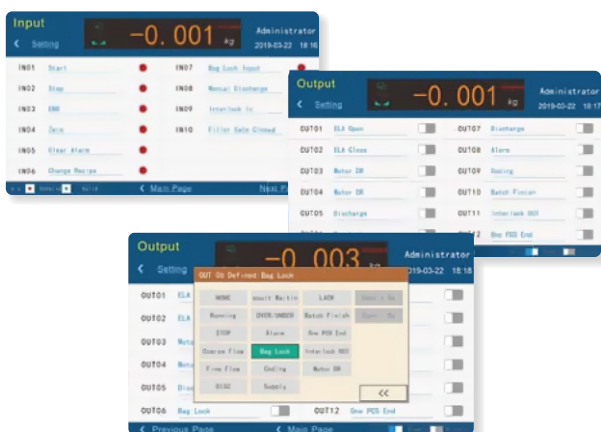

All definitions of each port can be intuitively selected.

# Specification

Model	PAB-05K, PAB-25K, PAB-50K, PAB-100K
Hardware	10 inch Touch Screen, Actuator, F301 Mainboard, 4G Signal Transmitter
Structure	Weigher Scale, Measuring Hopper, Electric Cabinet, Discharge Hopper
Filling Mode	Gravity/Stepper Motor
Controller	Touch Screen Bagging Controller
Communication	USB, RS232/485
Weighing Range	5~25 kg, 10~50 kg, 10~100 kg
Value for min.division	1, 2, 5, 10, 20, 50
Accuracy	+/- 10gm for 25kg, +/- 20gm for 50kg , +/- 50gm for 100kg
Speed	≤ 900 Bags Per Hour
Operating Temperature	0°C~40°C
Operating Humidity	90% R.H Condensation is not allowed
Power	AC 110 ~ 260V.50/60HZ. Approximate 200VA
Material	Food contacting material: SS304 stainless steel, others: SS201

## PAB-25K Dimension

Unit : mm

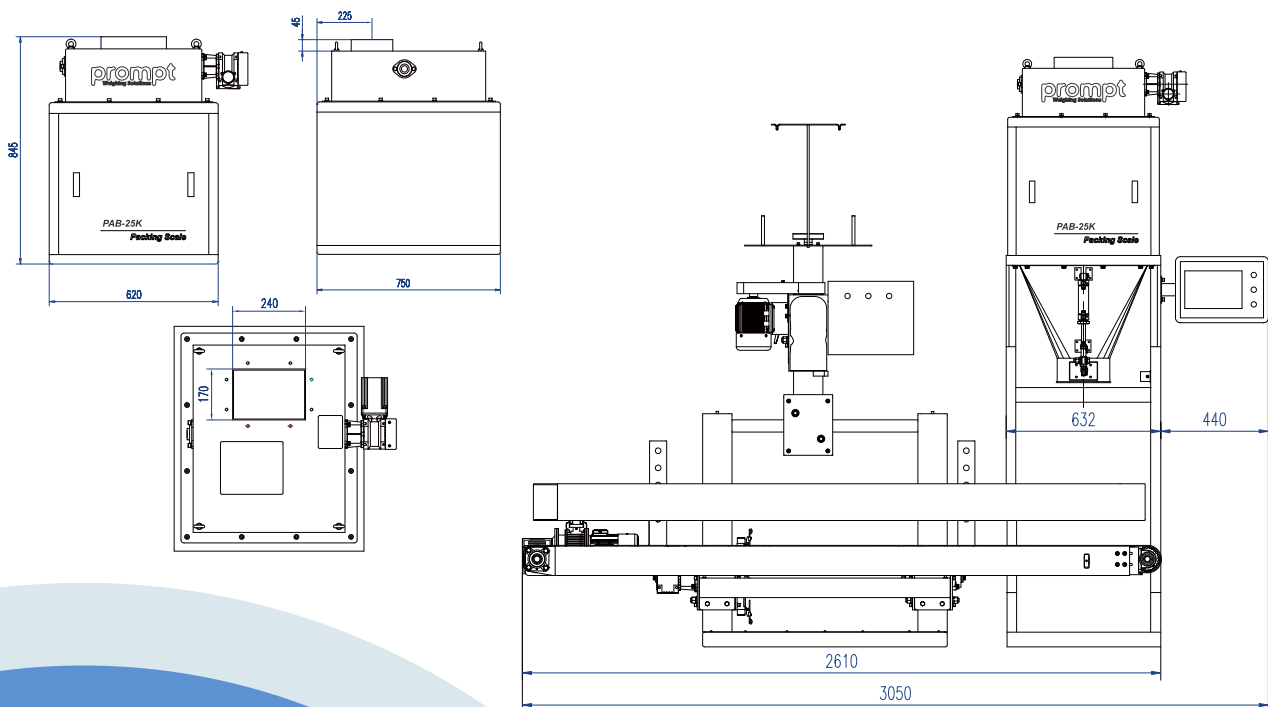

### PROMPT EQUIPMENTS PVT. LTD.

3-B, Vardan Exclusive, Nr. Stadium Petrol  
 Pump, Navrangpura, Ahmedabad, Gujarat – 380014  
 Phone: +91 79 26565981/82/83  
[www.promptscale.com](http://www.promptscale.com) | [sales@promptscale.com](mailto:sales@promptscale.com)