

Oval Wheel Meters, Type OV Flow Transmitter

METER™

Designed for the Process

- Direct measurement of volume respective of volumetric flowrate.
- Measurement at high viscosities
- High accuracy
- Only 2 moving parts (oval wheels)
- 2-wire-technique



Measuring Principle

Each revolution of the oval wheels displaces a precisely known volume of liquid through the meter, from inlet to outlet. The number of revolutions therefore is directly proportional to the measured volume. The pulses generated by a pulse transmitter with high pulse resolution are processed in the electronic converter/digital indicator. (Litres, Cubicmetres, Gallons, etc.).

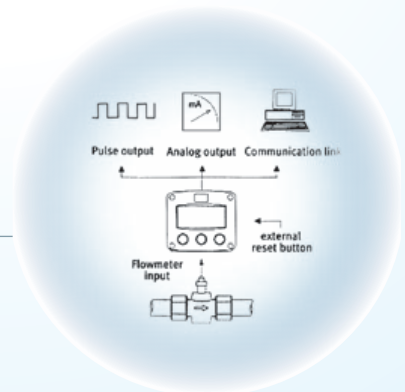

Accuracy

Between ± 0.1 and $\pm 0.3\%$ of actual flow depending upon meter type range and type of liquid. In general oval wheel meters give better accuracy and rangeability for liquids with higher viscosity.

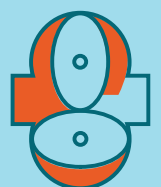
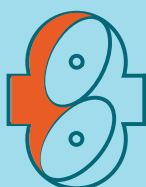
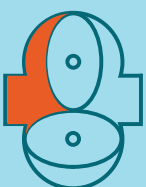

- ▶ Flow ranges for Toshniwal single case oval wheel meters: Expressed as a function of the viscosity of the liquid for normal applications. For cold/hot water or sulphuric acid, reduced measuring ranges are to be applied. These viscosities and flow ranges are given as a guide line only. Flow ranges for intermediate viscosities are to be interpolated
- ▶ For example, meter OV 400 can be used at continuous flow rate of 450 lpm at an operating viscosity of 2000 mPa.s

Basic Type	Int. Dia. (DN) in mm	Nominal Flow rate [l/min]	Ranges at viscosities	< 0.3 mPa · s		0.3–1.5 mPa · s		1.5–150 mPa · s		up to 350 mPa · s	
				[l/min]	[m³/h]	[l/min]	[m³/h]	[l/min]	[m³/h]	[l/min]	[m³/h]
OV2	25	35	min	5.5	0.33	3.3	0.33	3.5	0.2	1.65	0.1
			max	27.5	1.65	33	2	35	2.1	16.5	1
			continuous serv.	11	0.66	22	1.3	31.5	1.9		
			batching			30	1.8	35	2.1		
OV5	25	55	min	9	0.55	5.5	0.33	5.5	0.33	2.75	0.17
			max	45	2.75	55	3.3	55	3.3	27.5	1.65
			continuous serv.	18	1.1	36	2.2	44	2.6		
			batching			50	3	50	3		
OV10	25	110	min	18	1.1	11	0.66	11	0.66	7.7	0.46
			max	90	6.6	110	6.6	110	6.6	77	4.6
			continuous serv.	36	2.2	70	4.2	88	5.2		
			batching			100	6	100	6		
OV50	50	350	min	55	3.3	35	2.1	35	2.1	20	1.18
			max	275	16.5	350	21	350	21	200	12
			continuous serv.	110	6.6	230	13.8	280	16.8		
			batching			330	19.8	315	18.9		
OV115	65	550	min	90	5.5	55	3.3	55	3.3	35	2.1
			max	450	27	550	33	550	33	350	21
			continuous serv.	180	11	360	21.6	440	26.4		
			batching			500	30	500	30		
OV200	80	800	min	120	7.2	80	4.8	80	4.8	55	3.3
			max	600	37.5	800	48	800	48	550	33
			continuous serv.	240	15.5	480	28.8	640	38.4		
			batching			640	38.4	720	43.2		
OV400	100	1350	min	220	13.2	135	8	135	8.1	110	6.6
			max	1100	66	1350	79	1350	81	1100	66
			continuous serv.	440	26.5	810	48.6	1100	66		
			batching			1080	64.8	1210	72.6		

[1 mPa · s = 1 cP]

* Double casing design available in 3", 4" & 6" sizes (refer catalog: loading meters)

** Meters for viscosities above 350 cP available on request

* Operating temperature 110° C, Normal (60° C for some materials) for temperatures upto 180° C (only Ag 43), heat extension (300 mm) and special tolerance are provided

Error Curves

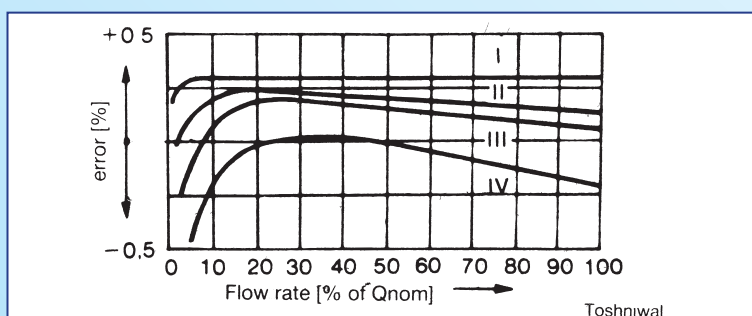

- I for liquids with Viscosity 100 cP (mPa·s)
- II for liquids with Viscosity 6 cP (mPa·s)
- III for liquids with Viscosity 1.5 – 6 cP (mPa·s)
- IV for liquids with Viscosity 0.5 – 1.5 cP (mPa·s)

Pressure drops across different types and designs of oval wheel meters series OV

Meters with normal both profile and graphite bushings (sleeve bearings)

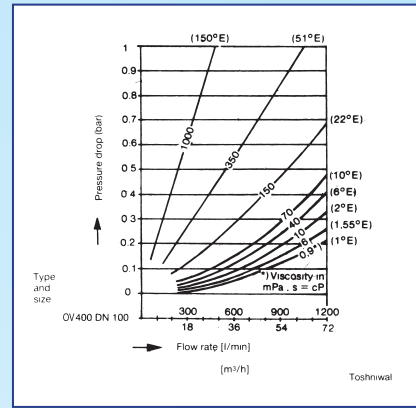
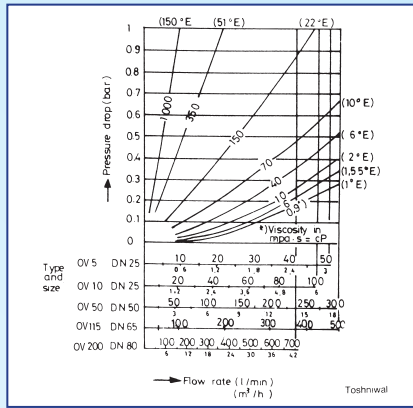

Meters with special tooth profile and graphite bushings (sleeve bearings).

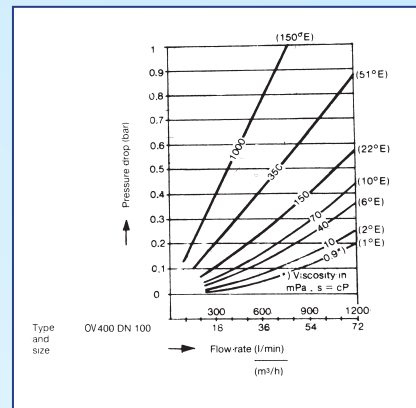
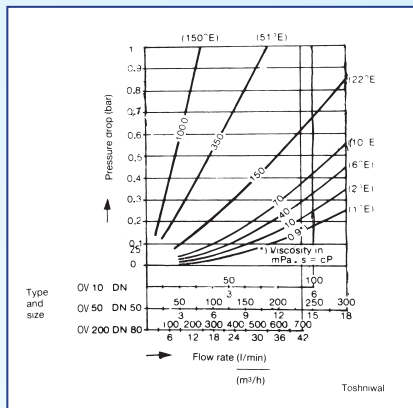

Dimension, Flanges :

Dimension in mm

Din	25	25	50	65	80	100
Type OV	...5	...10	...50	...115	...200	...400
Dimensions Din	ANSI150(L)	220	220	300	380	450
	ANSI300					
H1	169	172	190	249	256	292
DØ	135	150	245	305	365	445
h	52	72	104	138	145	183

Design (also available with heating jacket)		
Size	Material Group	PN
DN 25	G2,F2,F5	PN40
DN50	G2,F2,F5	PN40
DN65	G2,F5	PN25
DN80	G2,F5	PN25
DN100	G2,F5	PN25

Material Group	Body	Oval Wheels
G2	cast steel	cast iron
F2	cast steel	stainless steel
F5	stainless steel	stainless steel
G2,F2,F5	Bearings: Graphite	

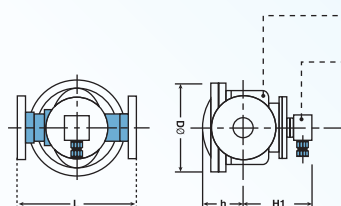

Note :-

1. Oval wheel meter with Ag 43 / Ag 50 / Ag01 - 09

2. Terminal box OR local indicator / totalizer

Local indicator / totalizer can be kept upto 5 metres away from the FLOW METER.

Ag 43 – Namur Sensor
Ag 50 – Reed Sensor
Ag01 - 09 – Encoder

Flanges acc.DIN or ANSI
RF (class 150 / 300)

others: upon request

Application & Accessories

For the protection of Oval wheel meters and turbine meters against foreign matter and solids contained in the liquids measured with these meters. These strainers may also be used for protection of piping systems for contamination. Strainers: Type Nwithout heating jacket Sizes 15-100mm(1/2" to 4")

Design & Operation

Strainers size 15-100mm consist of a cast body and a filter element (basket) The liquid flows through the filter basket from its top where foreign matter or solids are retained by the fine wire mesh. For cleaning, the filter basket can easily be removed, after removal of the cover of the filter housing. At the base, the strainer is provided with a drain plug and with an eye bolt or hexagon nut on the top for ventilation. The direction of flow is marked by an arrow cast onto the housing

Pressure Loss

Depending on Strainer size, flow rate and viscosity (filter basket clean) max. differential Pressure for contaminated strainer 3 bar

Filter basket

Perforated sheet-metal with wire mesh of stainless steel for all types mesh size 0.25 mm (576 mesh/cm² = 250 μ) or with mesh size 0.1 mm (3600 mesh/cm² = 100 μ) Both mesh sizes have an open filtering surface of 37.8%. Upon request we can also supply these strainers with mesh size 0.5 mm

Other Accessories

- Centrifugal gas separators
- Pulse amplifiers/scalers/convertors
- Flowrate indicators
- Additional accessories on request
- Pulse transmitters
- Pulse counters/totalizers
- Batch controllers
- Heat extension

Type	Dn	Type N (without heating jacket)							Clearance for replacing filter basket B
		L	H	DØ	a	c	l ₁	l ₂	
N 1/	15	165	210	132	110	100	82,5	82,5	180
N 5/	25	185	210	132	110	100	92,5	92,5	180
N 10/	25	250	260	190	135	125	130	120	300
N 50/	50	330	325	255	170	155	175	155	400
N 115/	65	350	410	255	190	220	190	160	500
N 200/	80	410	435	320	215	220	220	190	530
N 400/	100	420	555	320	235	320	220	200	680

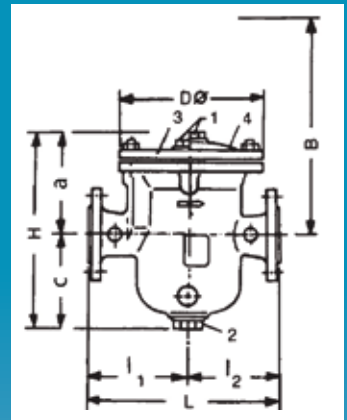

1. Hexagon nut for ventilation
2. Drain plug
3. Body cover (types N/F)
4. Body cover (types N/A0., N/A2)

Dimensions (in mm)
Strainers type N (without heating jacket)

Material:

Type	Body/Body Cover
N/A0	Cast iron
N/A2	Carbon steel
N/F	Stainless steel-316

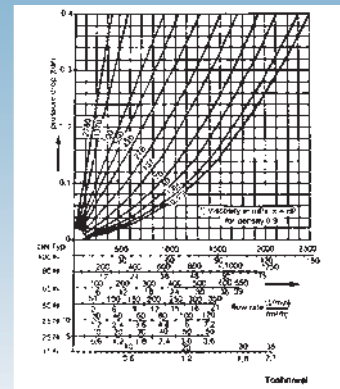

TOSHWIWA HYVAC PVT. LTD.

Chennai : 267, Kilpauk Garden Road, Chennai - 600 010, India. Tel: +91 44 26448983 / 26448558
Email: sales@tosshniwal.net / www.tosshniwal.net

Bangalore : Tel: +91 80 23519620 Email: bangalore@tosshniwal.net

Delhi : Tel: +91 11 26211134 Email: delhi@tosshniwal.net

Hyderabad : Tel: +91 40 23321631 Email: hyderabad@tosshniwal.net

Kolkata : Tel: +91 33 24740989 Email: kolkata@tosshniwal.net

Mumbai : Tel: +91 22 26591166 Email: mumbai@tosshniwal.net

Vadodara : Tel: +91 265 2987538 Email: baroda@tosshniwal.net