



Jaycee Technologies Private Limited
SHED NO.7, NANEKAR INDUSTRIES BUILDING
SURVEY NO. 79/2, DANGAT INDUSTRIAL ESTATE
SHIVANE , PUNE -411 023, INDIA
Mob : 9371068669 , 8554982251
Email : jayceetech@gmail.com sales@jayceetech.in Web : www.jayceetech.com



Vortex Flow Meter Model: LUGB

Vortex Flow Meter

Table of Contents

Table of Contents

- 1. General Information 3
 - 1.1 Product Description 4
- 2. Technical Data 5
- 3. Model and Selection 11
 - 3.1 Model Selection Table 11
 - 3.2 Converter Function Table 12
- 4. Cautions for Installation 13
 - 4.1 Mounting Positons 14
 - 4.2 Required Lengths of Runs 16
 - 4.3 Anti-Cavitation 17
 - 4.4 Connections 17
- 5. Electrical Wiring 1 21
 - 5.1 LUGB-N: Pulse Output, Explosion Proof Model 21

- 5.2 LUGB-A: Two wiring 4~20mA Output, No Local Display 21
- 5.3 LUGB-B; LUGB-C Series: Local Display 22
- 5.4 LUGB-D: Local Display 25
- 6. Programming and Setup 26
 - 6.1 LUGB-N: No Display; Pulse Output 26
 - 6.2 LUGB-A: No Display; 4~20mA Output 27
 - 6.3 LUGB-B, LUGB-C Series: Local Display 35
 - 6.4 LUGB-D1 with Temperature and Pressure Compensation 40
 - 6.5 LUGB-D2 with Temperature and Pressure Compensation 40
- 7. Troubleshooting 49
- 8. Quick Installation 50

1. GENERAL INFORMATION

This manual will assist you in installing, using and maintaining SURE flow meter. It is your responsibility to make sure that all operators have access to adequate instructions about safe operating and maintenance procedure.



Warning

For your safety, review the major warnings and cautions below before operating your equipment.

1. Use only fluids that are compatible with the housing material and wetted components of your Vortex.
2. When measuring flammable liquids, observe precautions against fire or explosion.
3. When handling hazardous liquids, always follow the liquid manufacturer's safety precautions.
4. When working in hazardous environments, always exercise appropriate safety precautions.
5. Handle the sensor carefully. Even small scratches or nicks can affect accuracy.
6. For best results, calibrate the meter at least 1 time per year.

1.1 Product Description

LUGB series Vortex flow meters are designed for measuring the volume/mass flow of liquids, gases and steam based on Karman vortex principle.

Adopting advanced differential algorithm along with measurement of isolation, shielding and wave filtering, LUGB series vortex flow meters have the advantages of immunity on vibration and noise. Meanwhile, the liabilities of LUGB series vortex flow meters are well guaranteed by unique sensor packaging technology.

Upon receipt, examine your meter for visible damage. The Vortex is a precision measuring instrument and should be handled carefully. Remove the protective plugs and caps for a thorough inspection. If any items are damaged or missing, contact us.

Make sure the Vortex flow model meets your specific needs. For your future reference, it might be useful to record this information on nameplate in the manual in case it becomes unreadable on the Vortex. Refer to the nameplate for your customized product's specification.

2. Technical Data

Measuring system

Application range	(1) Gas; (2) Liquid; (3) Steam
Measured value	
Primary measured value	Flow Rate
Secondary measured value	Volume flow ; (Pressure and Temperature is available for model with compensation)

Measuring accuracy

Reference conditions	Flow conditions similar to EN 29104
	Medium: Water / Gas
	Electrical conductivity: $\geq 300 \mu\text{S}/\text{cm}$
	Temperature: $+10\dots+30^\circ\text{C}$ / $+50\dots+86^\circ\text{F}$
	Inlet section: $\geq 10 \text{ DN}$
Flow meter accuracy	Operating pressure: 1 bar / 14.5 psig
	For Liquid: 1.0% of rate For gas and steam: 1.5% of rate

Design

Features	
Modular construction	The measurement system consists of a flow sensor and a signal converter. It is available as compact and as separate version.
Compact version converter	N Type: Pulse output without local display
	A Type: 4-20mA Output without local display
	B Type: Local Display; Lithium Battery Power; No Output (Battery Part No.: ER26500)
	C Type: Local Display; 24V DC Power; 4-20mA Output; Optional Function: (1) Backup Power Supply: Lithium Battery (2) Modbus RS485 (3) Pulse Output
Connection	Flange: DN15-DN300
	Wafer: DN15-DN300
Measurement ratio	Standard – 10:1

Operating conditions

Temperature	
Process temperature	T1 Level: -20...+70°C
	T2 Level: -20...+250°C
	T3 Level: -20...+350°C
Ambient (all versions)	Standard (with aluminum converter housing): -10...+55°C
Storage temperature	-20...+70°
Pressure	
EN 1092-1	DN200...DN300: PN10
	DN100...DN200: PN 16
	DN15...DN80: PN 25
	Other pressures on request
ASME B16.5	1/2" ...8": 150 lb RF
	Other pressures on request
JIS	1/2" ...8": 10 K
	Other pressures on request

Installation conditions

Installation	Take care that flow sensor is always fully filled
	For detailed information see chapter "Cautions for Installation"
Flow direction	Forward
	Arrow on flow sensor indicates flow direction.
Inlet run	≥ 10 DN
Outlet run	≥ 5 DN

Materials

Sensor housing	Ss304
	Other materials on request
Flanges	Ss304
	Other materials on request
Converter Housing	Standard: polyurethane coated die-cast aluminum

Process connections

Flange	
EN 1092-1	DN15...300 in PN 6...25
ASME	1/2" ...12" in 150 lb RF
JIS	1/2" ...12" in 10...20K
Design of gasket surface	RF
	Other sizes or pressure ratings on request
Wafer	DN15...DN300

Measurable flow rate range:

Nominal Diameter		Liquid	Gas
(mm)	(In.)	Flow (m ³ /h)	Flow (m ³ /h)
15	1/2"	1.2 to 6.2	5 to 25
20	3/4"	1.5 to 10	8 to 50
25	1"	1.6 to 16	10 to 70
40	1-1/2"	2.5 to 25	22 to 220
50	2"	3.5 to 35	36 to 320
65	2-1/2"	6.5 to 65	50 to 480
80	3"	10 to 100	70 to 640
100	4"	15 to 150	130 to 1100
125	5"	25 to 250	200 to 1700
150	6"	36 to 380	280 to 2240
200	8"	62 to 650	580 to 4960
250	10"	140 to 1400	970 to 8000
300	12"	200 to 2000	1380 to 11000

Note: The flow range as blow is for reference only. Consult the factory if you have special requirement. Refer to the nameplate or certificate for actual flow range.

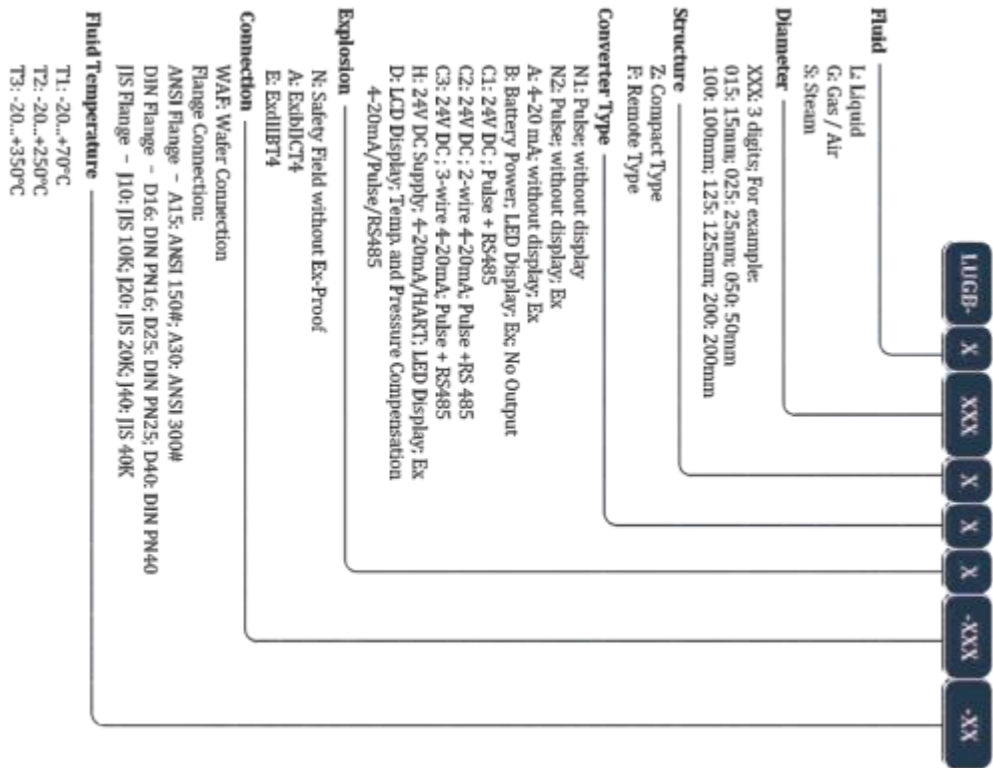

Model	Power Supply		Display	Output				
	Main Power	Dual Power (Battery)		Pulse	Scale Pulse	Current		Modbus RS485
						2-wire 4-mA	3-wire 4-20mA	
N1	24V DC			●				
N2	24V DC			●				
A	24V DC				●			
B	Battery		●					
C	C1	24V DC	○	●	●		○	
	C2	24V DC	○	●		●	○	
	C3	24V DC	○	●	●		●	
D	D1	24V DC		●			●	
	D2	24V DC		●		●	○	

NOT: N1 without Ex proof; N2, A, B, C1, C2, C3, D1, D2 with Ex proof. LUGB-D with Temperature and Pressure Compensation

Description of the symbols: ● Default Function ○ Optional

4. CAUTIONS FOR INSTALLATION

4.1 Mounting Positions

Pipes must be fully filled with liquids. It is essential that pipes remain fully filled at all times, otherwise flow rate indications may be affected and measurement errors may be caused.

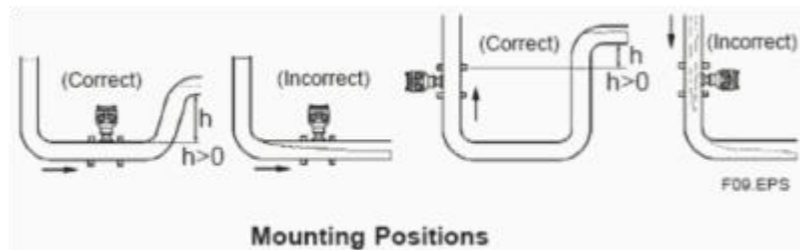

Avoid Air Bubbles. If air bubbles enter a measurement pipe, flow rate indications may be affected and measurement errors may be caused.

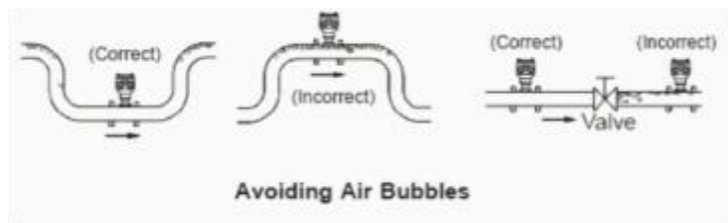

- ★ Avoid all pipe locations where the flow is pulsating, such as in the outlet side of piston or diaphragm pumps
- ★ Avoid locations near equipment producing electrical interference such as electric motors, transformers, variable frequency, etc.
- ★ Install the meter with enough room for future access for maintenance purposes

⚠ Warning: *Precaution for direct sunshine and rain when the meter is installed outside.*

4.2 Required Lengths of Straight Runs

Flow altering device such as elbows, valves and reducers can affect accuracy. See diagram below for typical flow meter system installation.

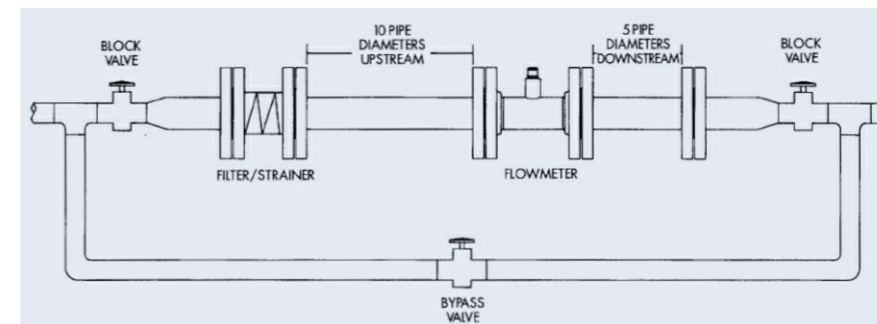
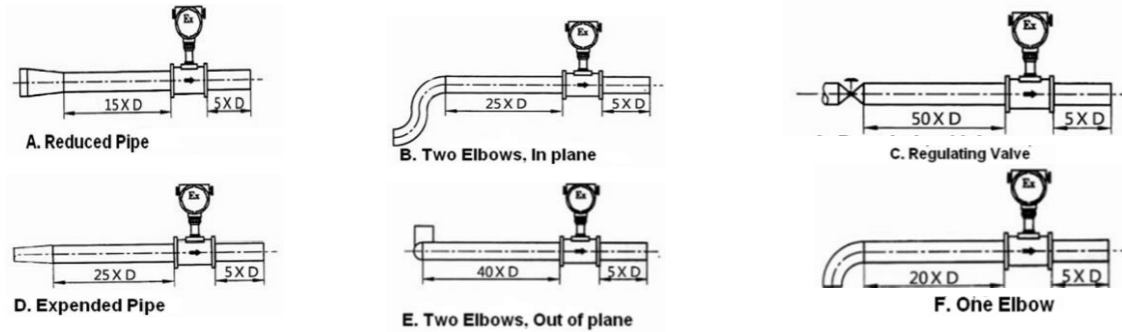

Diagram 1. Typical Flow Meter System Installation



The recommended guidelines are given to enhance accuracy and maximize performance. Distance given here are minimum requirements; Double them for desired straight pipe lengths.

- ★ Upstream: allow a minimum straight pipe length at least 10 times the internal diameter of the pipe. For example, with the 50mm pipe, there should be 500mm of straight pipe immediately upstream. Desired upstream straight pipe length is 1000mm.
- ★ Downstream: allow a minimum straight pipe length at least 5 times the internal diameter of the pipe. For example, with the 50mm pipe, there should be 250mm of straight pipe immediately upstream. Desired upstream straight pipe length is 500mm.

4.3 Anti-Cavitation

Cavitation can be caused by entrained air. An amount higher than about 100 mg/l of entrained air or gas can produce error. In addition, cavitation can be caused by too little backpressure on the flow meter. For our Vortex flow meters, you should provide a backpressure (downstream pressure) of at least 1.25 times the vapor pressure, plus 2 times the pressure drop through the flow meter. See formula 1.

$$\text{Formula 1: } P_b \geq 1.25 \times P_v + 2 \times (P_{in} - P_{out})$$

In formula 1: (P_b: Back pressure; P_v: Vapor Pressure; P_{in}: Inlet Pressure; P_{out}: Outlet Pressure)

Create backpressure by installing a control valve on the downstream side of the meter at the proper distance detailed above.

Special Notice

- ★ When the fluid is liquid, to ensure accurate measurement, drain all air from the system before use
- ★ When the meter contains removable coverplates. Leave the coverplate installed unless accessory modules specify removal. Don't remove the coverplates when the meter is powered, or electrical shock and explosion hazard can be caused.

4.4 Connections

4.4.1 Flange Connection

Installation	Take care that flow sensor is always fully filled
	For detailed information see chapter "Cautions for Installation"
Flow direction	Forward
	Arrow on flow sensor indicates flow direction.
Inlet run	≥ 10 DN
Outlet run	≥ 5 DN

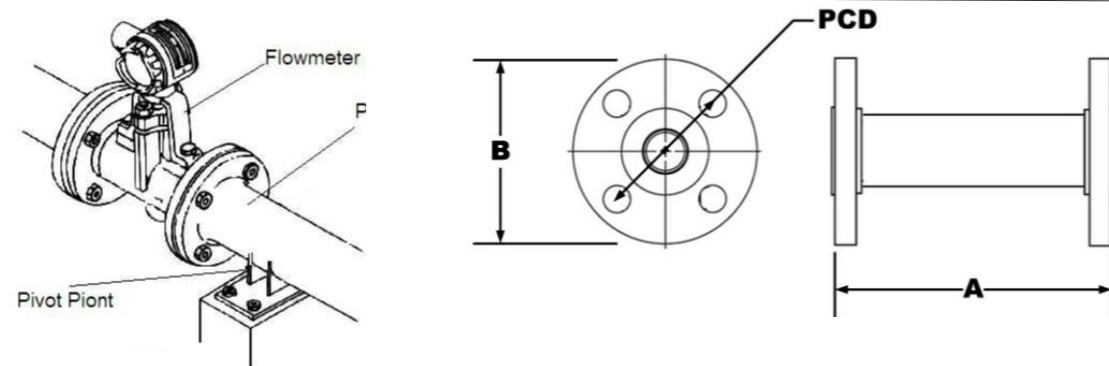

DIN Flange Meter Dimensions

Size Code		A	DIN Flange Pressure Rating	Flange Diameter (B)	Bolt Hole Diameter	Bolt Circle Diameter (PCD)	Bolt Hole Quantity
(Inch)	(mm)	(mm)	Mpa	(mm)	(mm)	(mm)	
1/2"	15	180	1.6	95	14	65	4
3/4"	20	180	1.6	105	14	75	4
1"	25	180	1.6	115	14	85	4
1-1/4"	32	180	1.6	140	18	100	4
1-1/2"	40	180	1.6	150	18	110	4
2"	50	180	1.6	165	18	125	4
2-1/2"	65	200	1.6	185	18	145	4
3"	80	200	1.6	200	18	160	8
4"	100	200	1.6	220	18	180	8
5"	125	220	1.6	250	18	210	8
6"	150	220	1.6	285	22	240	8
8"	200	220	1.6	340	22	295	12
10"	250	250	1.6	405	26	355	12
12"	300	300	1.6	460	26	410	12

Note: For model with temperature and pressure compensation, the flowmeter length should be increased 50mm compared to the value (A) in table above.

4.4.2 Wafer Connection

Installation	Take care that flow sensor is always fully filled
	For detailed information see chapter "Cautions for Installation"
Flow direction	Forward
	Arrow on flow sensor indicates flow direction.
Inlet run	≥ 10 DN
Outlet run	≥ 5 DN

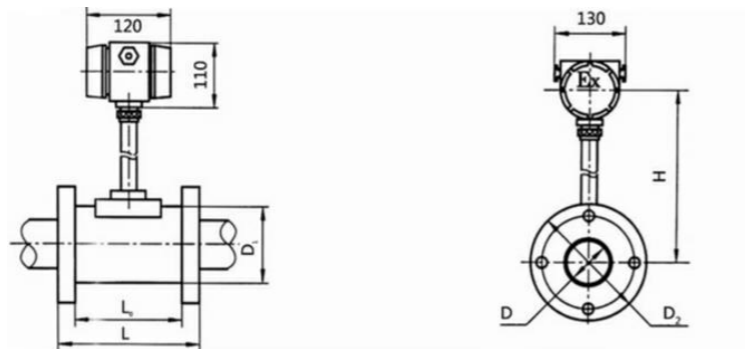

Diameter D (mm)	Pipe Specification	H	L	L0	D1	D2
15	Φ19×1.5	290	116	80	68	135
20	Φ26×3	290	116	80	68	135
25	Φ32×3.5	290	116	80	68	135
40	Φ49×4.5	295	116	80	80	140
50	Φ59×4.5	300	116	80	88	145
65	Φ74×4.5	308	116	80	105	165
80	Φ89×4.5	315	116	80	120	180
100	Φ109×4.5	328	118	80	148	210
125	Φ133×4.5	340	124	85	174	235
150	Φ159×4.5	351	135	90	196	270
200	Φ219×9	378	150	105	250	325
250	Φ273×11	402	166	120	300	375
300	Φ325×12	428	185	135	350	425

5. Electrical Wiring

Warning: *Electrical Hazard Disconnect power before beginning wiring.*

5.1 LUGB-N: Pulse Output, Explosion Proof Model



Terminal Configuration

Terminal Symbols	Description
+	Power Supply: "24V+"
-	GND
	Pulse Output

Terminal Wiring

5.2 LUGB-A: Two-wire 4-20mA Output, No Local Display

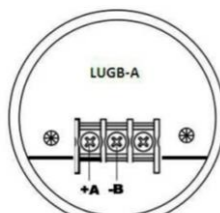

Terminal Configuration

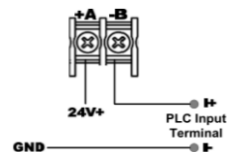

Terminal Symbols	Description
+A	Power Supply: "24V+"
-B	Current Output

Terminal Wiring

5.3 LUGB-B, LUGB-C Series: Local Display

Note: Terminal configuration is same for LUGB-B, LUGB-C series, but some functions are ONLY available on specified model. The table lists the function of each model.

Function	1	2	3
Original Pulse Output	ON	OFF	OFF
Scaled Pulse Output: 1L/Pulse; 10L/Pulse; Configure it in parameter setting 100L/Pulse	OFF	ON	OFF
Terminal Wiring	OFF	OFF	ON

5.3.1 LUGB-B: If the display is blank, put the plug of battery into the battery socket (BAT1).

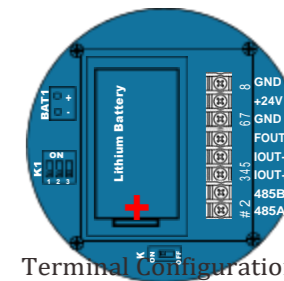

Terminal Configuration

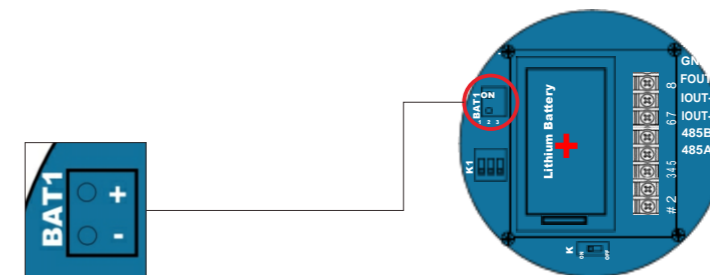

5.3.2 LUGB-C Series

Model	Function (Optional)	Terminal Code	Terminal Symbols	Description
LUGB-C	C1 Pulse & RS485 Output	7	+24V	24V DC+ Power Supply
		8	GND	GND
		5	FOUT	Pulse output+
		6	GND	Pulse output-
		1	485A	Rs485+
		2	485B	Rs485-
	C2 (2 wires) 4-20mA Output	3	IOU+	24V DC+ Power Supply
		4	IOU-	GND
	C3 (3 wires) 4-20mA & Pulse & RS485 Output	7	+24V	24V DC+ Power Supply
		8	GND	GND
		4	IOU-	Current output 4-20mA
		5	FOUT	Pulse output +
		1	485A	RS485+
		2	485B	RS485-

5.3.3 LUGB-C

Electrical Wiring Diagram

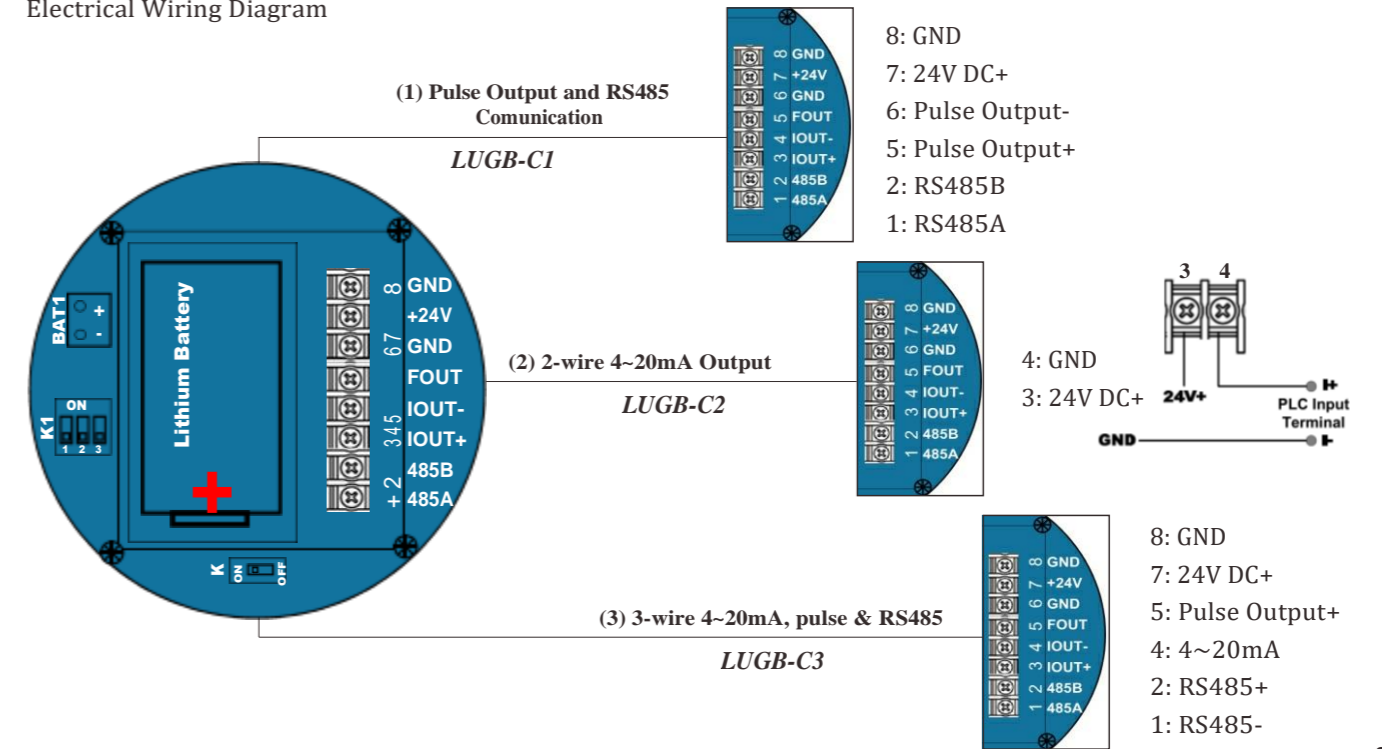

5.4 LUGB-D: Local Display (Temperature & Pressure Compensation)

5.4.1 LUGB-D1: Local Display (Temperature & Pressure Compensation)

Note: this converter configures 3-wire 4-20mA Output.

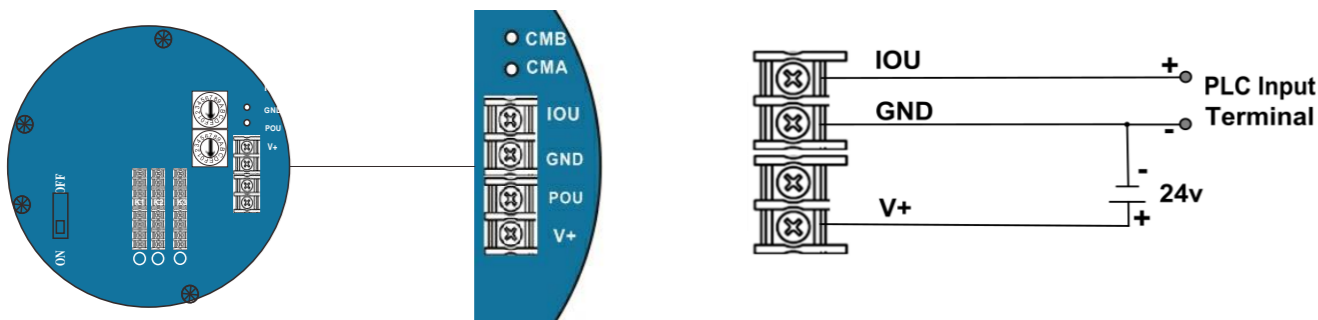

5.4.2 LUGB-D2: Local Display (Temperature & Pressure Compensation)

Terminal Configuration

(1) Main Power Supply and 4-20mA Output

Terminal Symbols	Description
+	Power Supply: "24V+"
-	4-20mA Current Output

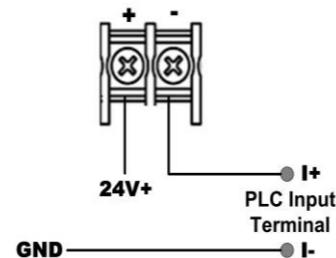

(2) Auxiliary Terminals

V+	Description
Fout	Pulse Output (Open-Collector with 1.5K Ohm Pull-up Resistor)
GND	4-20mA Current Output

Note: Auxiliary terminals can work ONLY when there is power supply for main power supply.

6. Programming and Setup

All flowmeters are tested and calibrated prior to leaving the factory, and the unique K-factor is provided on the calibration certificate. Keep the calibration certificate well to avoid the loss of K-factor.



6.1 LUGB-N: No display; Pulse Output

Customer should set the correct K-factor into PLC or Flow totalizer in order to get the correct flow rate.

6.2 LUGB-A: No display; 4-20mA Output

Only perform the Zero Point Calibration where it's necessary.

6.2.1 Zero Point Calibration

- (1) Shut off the valve where the flowmeter is installed, ensure there is no flow rate in pipe.
- (2) Put high accuracy amperometer into the circuit loop as series connection.

(3) Adjust the potentiometer W502 to make sure the display on amperometer is 4mA.

6.2.2 Full Scale Calibration: It's ONLY available for factory; Return the flowmeter to factory for full scale calibration where is applicable.



6.3 LUGB-B, LUGB-C Series: Local Display

Note: all menus are present in all signal converter versions, but some parameter settings are ONLY valid for specified models.

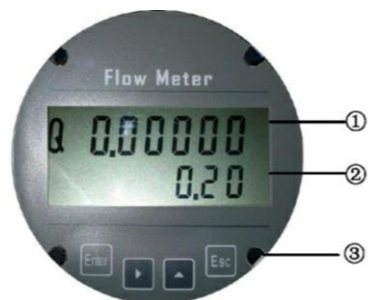
6.3.1 Display And Key



- ① Flow Rate
- ② Total Flow
- ③ Keys (See table below for function and representation in text)

Key	Measuring Mode	Menu Mode	Function Mode	Mode
Enter	1. Display the frequency corresponding to flow rate 2. Enter the parameter setting mode	Select menu	Press 1 time, return to menu mode, data saved	Save the value and advance to next menu
				For numerical values, move cursor one position to the right or left
			Select sub-menu or function	Use cursor highlighted to change number, unit, setting
Esc		Return to measuring mode but prompt whether the data should be saved	Return to measuring mode but prompt whether the data should be saved	Return to measuring mode but prompt whether the data should be saved

Note: Data are not saved when press "Esc" to return to measuring mode. If the value need to be changed, press "Enter" to save value first

6.3.2 Parameters Set

Press “Enter” two times at measuring mode, it leads to Password Menu “- - -”.

(1) Input correct password and press “Enter” can start parameter setting.

(2) Press “Enter” again and no password is input can ONLY view all parameters

The total menus in “Parameters Set” are 16, and users can access and modify these menus depending on the input password grade. See table below for more information on password grade.

Table. Description of Password Grade

Password Grade	Password	Login Privileges
Grade 1	No Password	Read Only
Grade 2	1234	Read and Edit
Grade 3	5678	Save all data as factory defaults
Grade 4	1111	Reload factory defaults

Note: Parameter setting can be ONLY performed by authorized engineer, as parameter change can affect the accuracy of the flowmeter

Menu	Parameter Name	Setting Method	Grades	Range
F---01	Flow Rate Unit	Select Parameter	Factory ONLY	1; 2; 3
F---02	Scaled Pulse Output In Liters	Select Parameter	User	1: 1 Liter/Pulse 10: 10 Liter/Pulse 100: 100 Liter/Pulse
F---03	Damping Time	Input Value	User	Unit: Second Value: 1-10
F---04	Maximum Flow Rate	Input Value	User	Unit: same as Flow Rate
F---05	Minimum Flow Rate	Input Value	User	Unit: same as Flow Rate
F---06	Maximum Frequency Output	Input Value	User	0-3000 Hz Accuracy: 0.1Hz
F---07	Baud Rate	Select Parameter	User	1200; 2400; 4800; 9600; 19200 Data Format: n; 8; 1
F---08	Device Address	Input Value	User	01-99
F---09	Frequency Output Model	Select Parameter	User	1; 2
F---10	Total Flow Reset	Input Value	User	Reset the new value and press “Enter” to confirm the change promptly.

Menu	Parameter Name	Setting Method	Grades	Range
P1	Linearization of the Flowcurve: point 1	Input Value	Factory ONLY	First Row: Frequency (P1) Second Row: K-Factor (P1)
P2	Linearization of the Flowcurve: point 2	Input Value	Factory ONLY	First Row: Frequency (P2) Second Row: K-Factor (P2)
P3	Linearization of the Flowcurve: point 3	Input Value	Factory ONLY	First Row: Frequency (P3) Second Row: K-Factor (P3)
P4	Linearization of the Flowcurve: point 4	Input Value	Factory ONLY	First Row: Frequency (P4) Second Row: K-Factor (P4)
P5	Linearization of the Flowcurve: point 5	Input Value	Factory ONLY	First Row: Frequency (P5) Second Row: K-Factor (P5)
P	Average	Input Value	Factory ONLY	First Row: Frequency (P) Second Row: K-Factor (P)

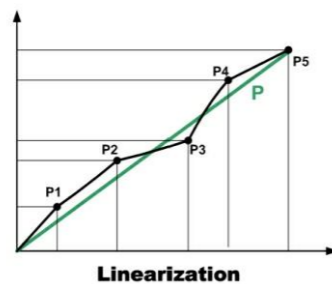

6.3.3 Parameter Function Table

No.	Function	Settings / Descriptions
F---01	Flow Rate Unit	Selectable: 1, 2, 3 1: m ³ ; 2: Liter; 3. Factory Reserved Consult the factory first to change the unit, as the K-factor should also be changed.
F---02	Scaled Pulse Output In Liters	Selectable: 1, 10, 100 1: 1 liter/Pulse; 10: 10 Liters/Pulse; 100: 100 Liters/Pulse Only valid for model supporting Pulse Output; and Position 3 of DIP Switch is ON, others two are OFF.
F---03	Damping Time	Value: 1-10 second; Recommended Value: 4 Second
Flow Range		
F---04	Maximum Flow Rate	Unit: same as Flow Rate
F---05	Minimum Flow Rate	Unit: same as Flow Rate

No.	Function	Settings / Descriptions
Frequency Output		
F---06	Maximum Frequency Output	Value: 0-3000 Hz Accuracy: 0.1Hz
RS485 Communication		
F---07	Baud Rate	Selectable: 1200; 2400; 4800; 9600; 19200 (Unit: Hz) Default Data Format: 9600, n, 8, 1
F---08	Device Address	Value: 01-99
F---09	Frequency Output Mode	Selectable: 1, 2 1: Original Pulse Output without linearization 2: Corrected Pulse Output after linearization
Reset Total Flow		

No.	Function	Settings / Descriptions
F---10	Total FlowReset	Reset the new value and press "Enter" to confirm the change promptly.
Linearization		
P1	Linearization of the Flowcurve: point 1	First Row: Frequency (P1) Second Row: K-Factor (P1)
P2	Linearization of the Flowcurve: point 2	First Row: Frequency (P2) Second Row: K-Factor (P2)
P3	Linearization of the Flowcurve: point 3	First Row: Frequency (P3) Second Row: K-Factor (P3)
P4	Linearization of the Flowcurve: point 4	First Row: Frequency (P4) Second Row: K-Factor (P4)
P5	Linearization of the Flowcurve: point 5	First Row: Frequency (P5) Second Row: K-Factor (P5)
P	Average K-Factor	First Row: Frequency (P) Second Row: K-Factor (P)

6.4 LUGB-D1 with Temperature and Pressure Compensation

 **Warning: Electrical Hazard Disconnect power before beginning wiring.**

6.4.1 Display and Keys

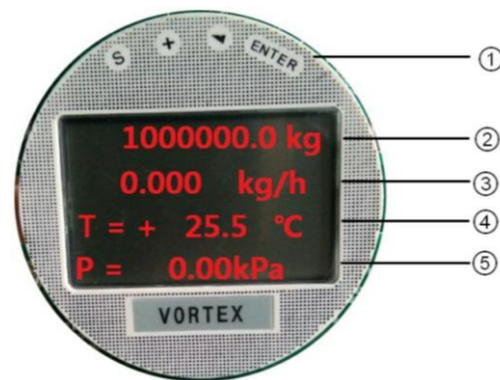

- ① Keys (See table below for function and representation in text)
- ② Total Flow
- ③ Flow Rate
- ④ Operating Temperature
- ⑤ Operating Pressure

6.4.2 Parameters Set

At main measuring mode, press “S” can switch to secondary measuring display, which has 3 Rows:

(1) Current Frequency; (2) Output Current; (3) Password.

Input the correct password, and press “Enter” can advance to parameter setting mode.

Note: default password “00”. Save the new password once it’s changed.

Key	Measuring mode	Menu mode
S	Switch between display pages: (1) Main Measuring Mode (2) Parameter Setting	Select menu
+		Use cursor highlighted to change number, unit, setting
<		For numerical values, move cursor one position to the right or left
Enter	Confirm to enter the parameter setting after correct password is input	Saved the parameter change
		At menu “Reset Password”, press “Enter” can lead to measuring mode.

6.4.3 Parameter Function Table

No.	Menu	Settings / Descriptions
1	Flow Unit Selection	Flow Rate Unit: Selectable 0-6
		0: m ³ /hr; 1: m ³ /min; 2: Liter/hr; 3: Liter/min
		4: t/hr; 5: t/min; 6: kg/hr; 7: kg/min
2	Multi-segment Broken Lines	Linearization of the Flowcurve
		Y: Enable the linearization of the Flowcurve
		N: Disable the linearization
3	Algorithm Selection	Selectable: 1-12
		01: Volume flow of conventional liquids
		02: Liquid volume of temperature compensation
		03: Volume flow of conventional gases
		04: Gas volume of compression coefficient
		05: Volume flow of thermal-pressure coefficient
		06: Conventional mass flow
		07: Mass flow of temperature compensation

No.	Menu	Settings / Descriptions
3	Algorithm Selection	08: Mass flow of compression coefficient
		09: Mass flow of multi-segment broken lines
		10: Temperature compensation of saturated steam
		11: Pressure compensation of saturated steam
		12: Temperature and pressure compensation of overheated steam
4	Broken Line Gas-Liquid Selection	Selection:0-1
		0: Fluid is Gas; 1: Fluid is liquid
5	Flow Coefficient	Flowmeter K-factor
		Unit: Pulse /m ³
		It means how many pulse for one cubic meter
6	Maximum Output Flow	Maximum Flow Rate
7	Platinum Resistance Selection	Temperature Sensor Type. Selectable: 0-1
		0: PT100; 1: PT1000
8	Setting Density	Set Fluid density; Unit: Kg/m ³
9	Reset Cumulant	Reset Total Flow
		Y: Reset total flow

No.	Menu	Settings / Descriptions
9	Rreset Cumulant	N: Don't reset total flow
10	Pmax	Maximum Pressure: set the Max. Pressure (Unit: Kpa)
11	Pmin	Maximum Pressure: set the Min. Pressure (Unit: Kpa)
12	Freq Out	Rs485 Communication device address
13	Communication No.	Rs485 Communication device address
		Optional Function
12	Qmin%	Flow Cutoff: if this value is 10%, then Min. Flow=0.1*Max. Flow which means the display remains as 0 if the flow rate is less which means the display remains as 0 if the flow rate is less than Min. Flow

6.5 LUGB-D2 with Temperature and Pressure Compensation

Note: all menus are present in all signal converter versions, but some parameter settings are ONLY valid for specified models.

6.5.1 Display and Keys

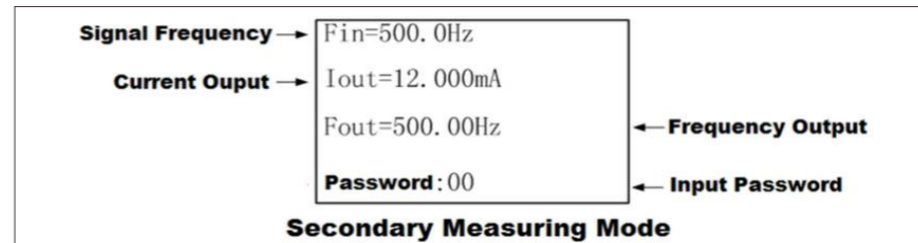
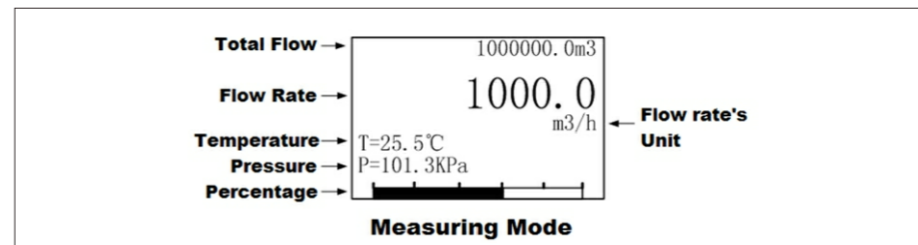

Key	Measuring Mode	Secondary Measuring Mode	Sub-menu or Function Mode	Parameter and Data Mode
+/S		1. At password input mode, “+/S” can increase the number 2. Use “</E” to move cursor		Change the value or select different parameter
</E		1. Press and Hold “</E” can enter password input mode. 2. At password input mode, press and hold “+/S” can back to secondary measuring mode	(1) Press and hold “</E” to enter current menu (2) Press and hold “</E” to save the data when the modification is finished	For numerical values, move cursor one position to the right or left

Press “+/S” and “</E” together to switch between Measuring Mode and Secondary Measuring Mode

Note: Press “+/S” and “</E” together to switch between Measuring Mode and Secondary Measuring Mode

6.5.2 Parameters Set

Table. Description of Password Mode

Password Level	Password	Login Privileges
Level 1	22	User Menu
Level 2	33	Engineering Menu
Level 3	44	Factory Menu

Note: parameter setting can be ONLY performed by authorized engineer, as parameter change can affect the accuracy of the flowmeter.

6.5.3 User manul

NO.	Function	Setting/Description
1	Language	0: Chinese 1: English
2	Flow rate's Unit (Default: 0)	0: m ³ /h (Nm ³ /h when Algorithm Selection = 2) 1: m ³ /min; 2: Liter/h; 3: Liter/min; 4: ton/h; 5: ton/min; 6: kg/h; 7: kg/min
3	Algorithm Selection (Default: 0)	0: Volume Flow 1: Mass Flow 2: Normative Volume Flow 3: Gas Mass Flow 4: Saturated Steam Temperature Compensation 5: Saturated Steam Pressure Compensation 6: Superheated Steam Temp. and Pressure Compensation
4	K-Factor [P/m] ³ XXX.XXXXXXXXX	Flowmeter's K-Factor
5	Fluid Density (kg/m) ³ XXXX.XXXX Default: 1000.0	This menu should be set when Algorithm Selection = 1 or 3 Unit: Kg/m ³

NO.	Function	Setting/Description
6	Max. Flow Rate XXXXXX.XX	This menu must be set and can't be 0. Unit is same as Flow rate's Unit
7	Low Flow Alarm XXXXXX.XX	This menu must be set and can't be 0. Unit is same as Flow rate's Unit
8	Low Flow Cutoff % XX.X	Value: 0-20% Default: 1%; which means the flow will be cut when it's less than 1%Max Flow
9	Damping XX	Value: 2-32 The damping time for current output and frequency Default: 4S
10	HART Address	Value: 0-15 Default: 0
11	Password: Reset Total Flow	When Reset Total Flow is required, input password "70" and press "</E"

6.5.4 Engineering Menu

NO.	Function	Setting/Description
1	Input Signal Frequency Range	Set the correct frequency range, or may cause trouble
2	Pulse Output Type	Select the correct pulse output
3	Scaled Pulse Output	Only valid for pulse output; 0 is not permit
4	Correction Function and corresponding Percentage	Five Point Linearization (Don't change this setting or can affect the accuracy)
5	Temperature and Pressure Display Enable/Disable	(1) Enable: Temperature and Pressure display (2) Disable: Temperature and Pressure will not display
6	Temperature Sensor Type	PT100 PT1000

NO.	Function	Setting/Description
7	Temperature at standard state	(1) Standard Temperature: 0°C (2) Standard Temperature: 20°C
8	Reference Pressure	(1) Absolute Pressure Sensor: 0 (2) Gauge Pressure Sensor: Local Atmospheric Pressure (Unit: KPa)
9	Default Pressure	For only temperature compensation type
10	Default Temperature	For only pressure compensation type
11	50 Hz Interference Suppression	Hz to 50.5 Hz (1) Enable: input signal will be cut and ignored between 49.5 Hz to 50.5 Hz (2) Disable: don't suppress 50 Hz Signal
12	Converter Ambient Temperature	(1) -10°C: normal display (2) -20°C: display refresh every 8 second

6.5.5 Factory Menu

 **Warning: ONLY Factory can modify these menus, or it can cause trouble or damage**

NO.	Function	Setting/Description
1	Initial Setting based on different password	70: ave current parameter setting as initial value and save into EEPROM Register 90: Backup all parameters to MCUF Register 79: Reload the parameter setting from MCUF to EEPROM
2	Pt100 Calibration	Connect accurate 100 Ohm Resistor and perform the calibration
3	PT200 Calibration	Connect accurate 200 Ohm Resistor and perform the calibration
4	PT1000 Calibration	Connect accurate 1000 Ohm Resistor and perform the calibration
5	PT2000 Calibration	Connect accurate 2000 Ohm Resistor and perform the calibration

NO.	Function	Setting/Description
6	Max. Fluid Pressure	Set the Max. Fluid Pressure
7	Max. Pressure Calibration	Calibrate it when the pressure reaches steady Max. Pressure
8	Min. Fluid Pressure	Set the Min. Fluid Pressure
9	Min. Pressure Calibration	Calibrate it when the pressure reaches steady Min. Pressure
10	4mA Output Calibration	Use high accuracy amperemeter to get 4mA Output, and perform this calibration
11	12mA Output Calibration	Use high accuracy amperemeter to get 12mA Output, and perform this calibration
12	20mA Output Calibration	Use high accuracy amperemeter to get 20mA Output, and perform this calibration

7. Troubleshooting

Symptom	Probable Cause	Solution
Measurement is not accurate	1. Parameter wrong	Check the parameters (Transmitter, detector factor and size)
	2. Pipe is not fully filled	Check if meter is fully filled
Flow rate indication is unstable	1. Vibration Problem	Add support to the line near the meter to damp the vibration
	2. Air	Make sure fluid does not contain air bubbles when fluid is liquid
	3. Amplifier location - outside electrical interference	Make sure amplifier is not too close to sources of electrical interference
No Display	1. No power	Apply correct power
	2. Incorrect power	Check power value
	3. Wiring connections	Check power input/output connections

8. Quick Installation

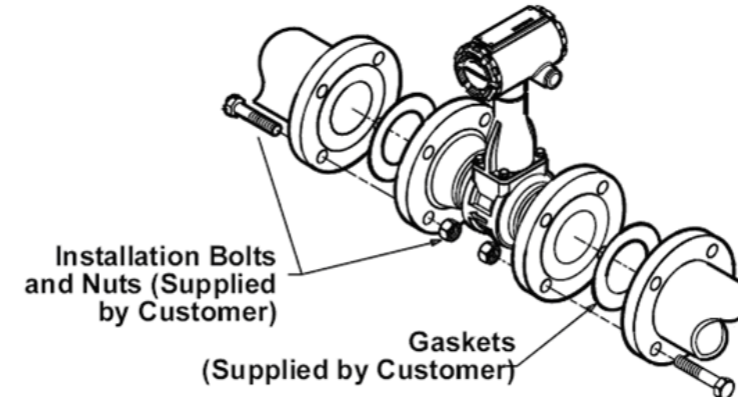

Flange-Style Flow Meter Installation

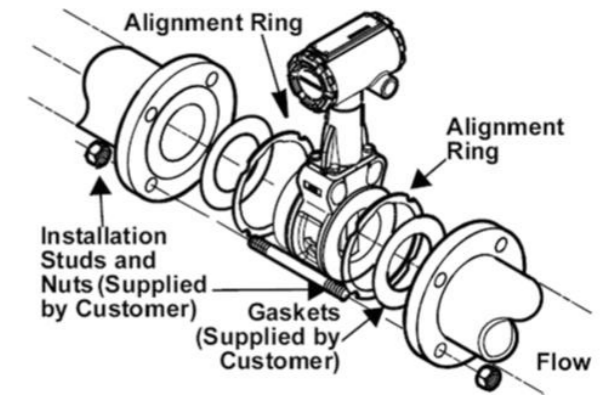

Wafer-Style Flow Meter Installation