

- For continuous level measurement of liquids (even if polluted), mash and paste materials in open or closed vessels, sumps, open channels, etc.
- Variants of level meter with adjustment by two buttons, or by magnetic pen
- Xi version for usage in explosive areas
- State indication by two LEDs
- Current output (4 ... 20 mA), voltage output (0 ... 10 V) or RS-485 Modbus output
- Wide choice of electric connection via connectors, cable glands or protective conductor
- While used with horn adapter can be measured also some difficult media (foamy levels, loose materials, etc.)



The ULM® ultrasonic level meters are compact measurement devices containing an ultrasonic transmitter and an electronic module. Using an transmitter, level meters transmit the series of ultrasonic pulses that spread towards the level surface. The transmitter recuperates reflected acoustic waves that are subsequently processed in the electronic module. Based on the period during which the individual pulses spread towards the level and back, this period is averaged by the electronics that performs temperature compensation and subsequently a conversion to an output current 4 - 20 mA, voltage 0 - 10 V or output RS-485 Modbus.

The ULM® ultrasonic level meters are suitable for continuous non-contact level measurement of liquids (water solutions, sewerage water, etc.), mash and paste materials (sediments, sticks, resins etc.) in closed or open vessels, sumps, reservoirs and open channels. In case the level of bulk-solid materials is measured, the measurement range is reduced.

All setting-up is done using two buttons positioned in the upper part of the sensor. The level meter is equipped with optical state indication (STATE) and with a setting-up process (MENU). The level meter can output current or voltage signals. They are manufactured in model versions for non-explosive areas (N) and explosive areas (Xi).

### FEATURES OF VARIANTS

- **ULM-53\_-01\_-** **Measuring range from 0.1 m to 1 m**, plastic PVDF transmitter and plastic body (PP+HDPE), process connection with thread G ¾".
- **ULM-53\_-02\_-** **Measuring range from 0.2 m to 2 m**, plastic PVDF transmitter and plastic body (PP+HDPE), process connection with thread G 1".
- **ULM-53\_-06\_-** **Measuring range from 0.2m to 6 m**, plastic PVDF transmitter and plastic body (PP+HDPE), process connection with thread G 1 ½".
- **ULM-53\_-10\_-** **Measuring range from 0.4 m to 10 m**, plastic PVDF transmitter and plastic body (PP+HDPE), process connection with thread G 2 ¼".
- **ULM-53\_-20\_-** **Measuring range from 0.5m to 20 m**, with plastic PVDF transmitter and plastic body (PP+HDPE), aluminium alloy flange.

# DIMENSIONAL DRAWINGS

**ULM-53\_-01**

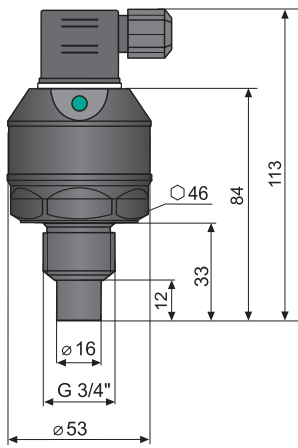

**ULM-53\_-02**

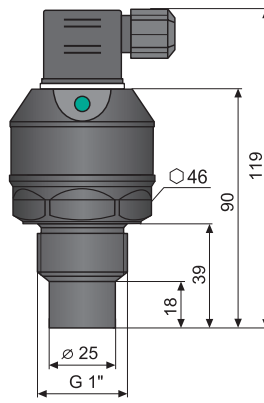

**ULM-53\_-06**

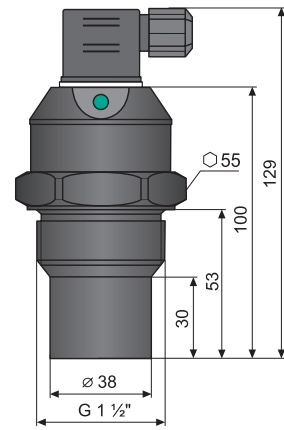

**ULM-53\_-10**

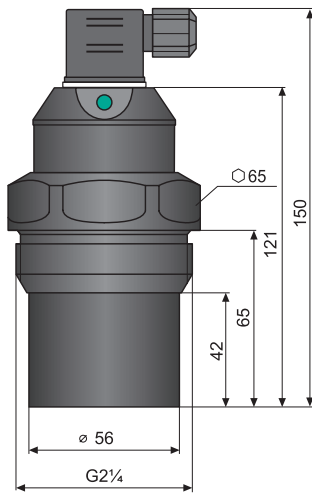

**ULM-53\_-20**

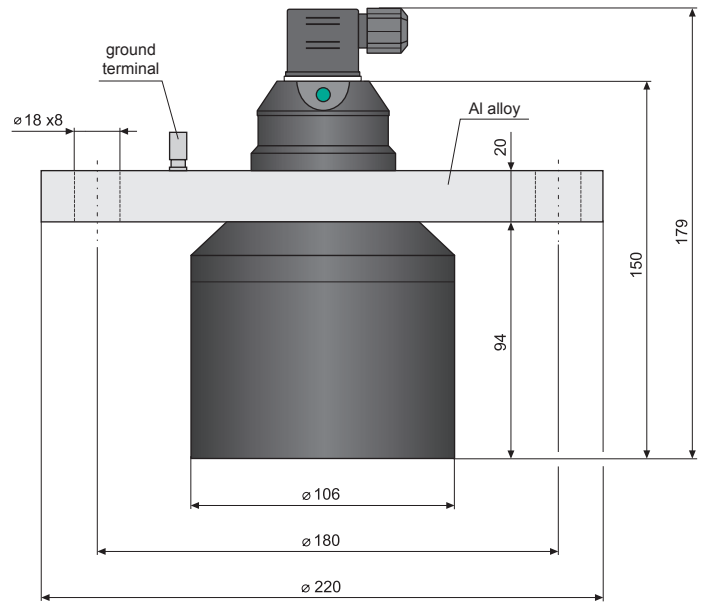

**Variant "G" with connector ISO**

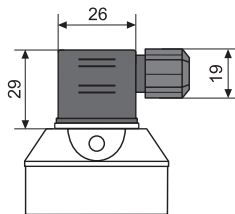

**Variant "C" with connector M12**

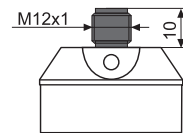

**Variant "B" with cable outlet PG11**

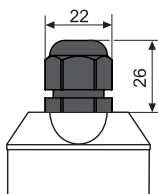

**Variant "H" with outlet for protective conductor**

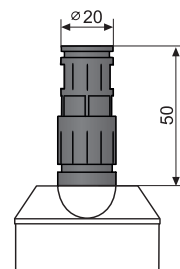

## TECHNICAL SPECIFICATIONS

Measuring range <sup>1)</sup>	ULM-53_-01-_	0.1 ... 1 m
	ULM-53_-02-_	0.2 ... 2 m
	ULM-53_-06-_	0.2 ... 6 m
	ULM-53_-10-_	0.4 ... 10 m
	ULM-53_-20-_	0.5 ... 20 m
Supply voltage	ULM-53N-___-	18 ... 36 V DC
	ULM-53Xi-___-I	18 ... 30 V DC
Current supply	ULM-53N(Xi)-___-I	4 ... 20 mA / max. 22 mA
	ULM-53N-___-U	Max. 12 mA
	ULM-53N-___-M	Max. 20 mA
Current output ULM-53_-___-I Voltage output ULM-53N-___-U Modbus output ULM-53N-___-M		4 ... 20 mA (limit values 3.9 ... 20.5 mA) 0 ... 10 V (limit values 0 ... 10.2 V) Modbus RTU protocol
Resolution		< 1 mm
Accuracy (within the total range)	ULM-53_-01_ in area 0,1–0,2 m / 0,2–1,0 m	0,3 % / 0,2 %
	ULM-53_-02_-;06-	0,15 %
	ULM-53_-10_-;20-	0,2 %
Temperature error		Max. 0,04% / K
Beamwidth (-3 dB)	ULM-53_-01_-; 02_-; 10_-	10°
	ULM-53_-06_-	14°
	ULM-53_-20_-	12°
Ambient temperature range	ULM-53_-01_-; 02_-; 06_-	-30 ... +70°C
	ULM-53_-10_-; 20_-	-30 ... +60°C
Measuring period	ULM-53_-01_-; 02_-	0,5 s
	ULM-53_-06_-; 10_-	1,2 s
	ULM-53_-20_-	5,0 s
	ULM-53_-___-M	adjustable via Modbus RTU
Averaging (can be modified according to agreement)	ULM-53_-___- ULM-53_-___-M	4 measurement adjustable via Modbus RTU
Short time temperature stress resistance		+90°C / 1 hod.
Max. operation overpressure (on transmission surface)		0,1 MPa
Max. internal values <sup>2)</sup> (for the Xi version only)		U <sub>i</sub> =30 V DC; I <sub>i</sub> =132 mA; P <sub>i</sub> =0,99 W; C <sub>i</sub> =370 nF; L <sub>i</sub> =0,9 mH
Failure indication	echo failure – basic mode	3,75 mA (0 V)
	echo failure – inverse mode	22 mA (10,5 V)
	level in dead zone – basic mode	22 mA (10,5 V)
	level in dead zone – inverse mode	3,75 mA (0 V)
Protection class		IP67
Recommended cable		PVC 2 x 0,75 mm <sup>2</sup> (3 x 0,5 mm <sup>2</sup> )
Maximal current output load resistance	at U = 24 V DC	R <sub>max</sub> = 270 Ω
	at U = 22 V DC	R <sub>max</sub> = 180 Ω
	at U = 20 V DC	R <sub>max</sub> = 90 Ω
Minimal voltage output load resistance		R <sub>min</sub> > 1 kΩ
Delay between supply power rise time and first measurement	ULM-53_-01_-; 02_-; 06_-	5 s
	ULM-53_-10_-; 20_-	9 s
Process connection	ULM-53_-01-_	thread G ¾"
	ULM-53_-02-_	thread G 1"
	ULM-53_-06-_	thread G 1½"
	ULM-53_-10-_	thread G 2¼"
	ULM-53_-20-_	aluminium alloy flange
Weight	ULM-53_-01-_	0,20 kg
	ULM-53_-02-_	0,20 kg
	ULM-53_-06-_	0,25 kg
	ULM-53_-10-_	0,65 kg
	ULM-53_-20-_	2,80 kg

<sup>1)</sup> In case the level of bulk-solid materials is measured, the measurement range is reduced.

<sup>2)</sup> Allowed pressure range in the zone 0: 80 ... 110 kPa.

## AREA CLASSIFICATION (according to EN 60079-10 and EN 60079-14)

ULM-53N-__-__	Performance for non-explosive areas
ULM-53Xi-01-I ULM-53Xi-02-I ULM-53Xi-06-I	Explosive proof – suitable for explosive areas (combustible gases or vapours) ⊕ II 1/2G Ex ia IIB T5 Ga/Gb with isolating repeater (IRU-420) the whole level meter – zone 1, front head part – zone 0
ULM-53Xi-10-I	Explosive proof – suitable for explosive areas (combustible gases or vapours) ⊕ II 1/2G Ex ia IIA T5 Ga/Gb with isolating repeater (IRU-420) the whole level meter – zone 1, front head part – zone 0
ULM-53Xi-20-I	Explosive proof – suitable for explosive areas (combustible gases or vapours) ⊕ II 2G Ex ia IIA T5 Gb with isolating repeater (IRU-420) the whole level meter – zone 1

## INSTALLATION

Level meter is installed into the upper lid of the tank (vessel), using a fixing nut or a flange.

If installed in an open channel (sumps, reservoirs, etc.), install the level meter as closest as you can to the maximum level expected.

The front of the level meter must run in parallel to the measured level.

Emitted acoustic signal must not be affected by near objects (stiffeners, ladders, mixers, unevenness, etc.), stream of filling, air flow, etc.

Foam on the level absorbs the acoustic wave reflection which might cause malfunction of the level meter. If possible select the location where the foaming is as low as possible. Protect the level meter against direct sunlight.

**In the case of uncertainty we recommend to consult the application with the producer.**

## MOUNTING RECOMMENDATION

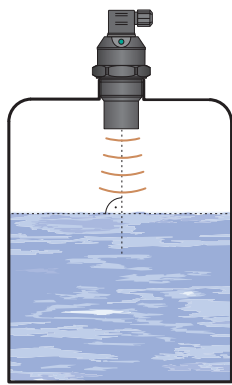

Recommended installation

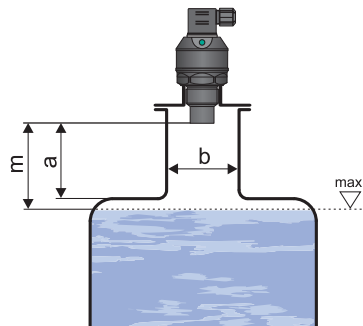

ULM-53-01; 02; 06	$a < 3b$ $b > 100 \text{ mm}$
ULM-53-10	$a < 1,5b$ $b > 100 \text{ mm}$
ULM-53-20	$a < 1,5b$ $b > 150 \text{ mm}$

a - neck height

b - neck width

m - dead zone

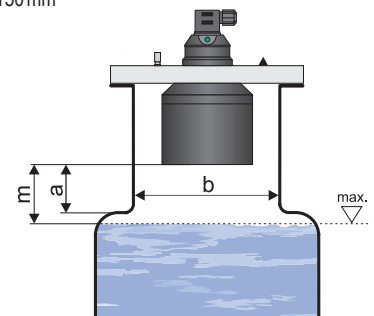

Possible installation through the neck

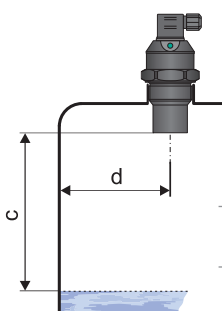

c - Maximum reach of the level meter  
d - Minimum distance from tank wall

ULM-53-01; 02; 10	$d > 1/12 c$ (min. 200 mm)
ULM-53-06	$d > 1/8 c$ (min. 200 mm)
ULM-53-20	$d > 1/10 c$ (min. 200 mm)

Installation distance from the tank wall

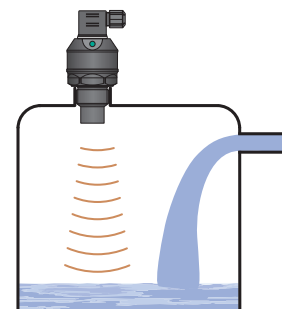
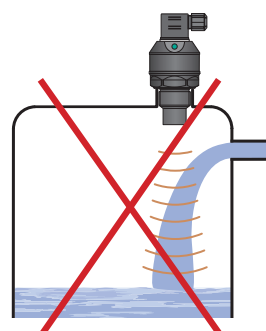

Level meter installation outside the influence of filling circulation

## ELECTRIC CONNECTION

### Connection through ISO connector

The ULM level meter with a G type cable gland are connected to processing (display) units by means of a cable with an outer diameter of 6 to 8 mm (recommended wire cross-section 0.5 to 0.75 mm<sup>2</sup>), via a detachable ISO connector with inner screw terminals, which is part of the delivery. The connection diagram and the inner view of the connector are shown in Figures on the right. Non-detachable connector IP67 with PVC cable 5 m long can be supplied as an extra option.

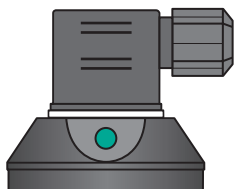

View of the connector ISO

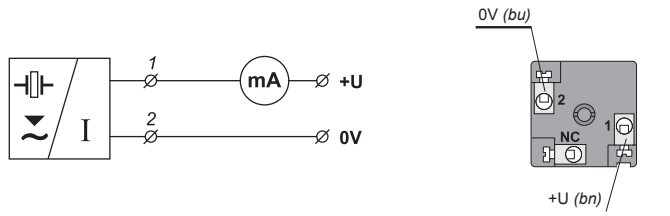

Connection diagram of the ULM level meter (variant -I) and inside view of the connector

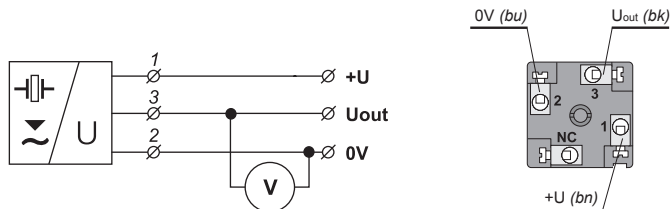

Connection diagram of the ULM level meter (variant -U) and inside view of the connector

### Connection through M12 connector

The ULM level meter with a C type cable gland are connected to processing (display) units by means of a cable with an outer diameter of 4 to 6 mm (recommended wire cross-section 0.5 to 0.75 mm<sup>2</sup>), via a connector socket with a moulded cable (2 or 5 m long) or via a detachable connector socket without a cable (see accessories). In this case connect the cable to the inner socket pins under figures on the right.

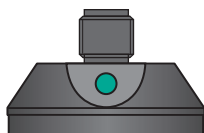

View of the connector M12

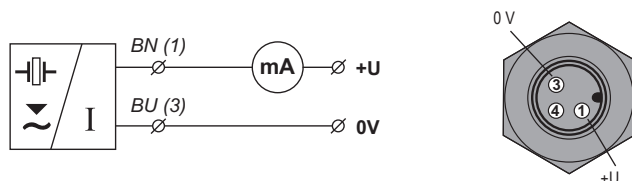

Connection diagram of the ULM level meter (variant -I) and inside view of the connector

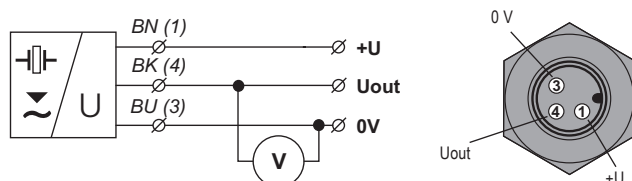

Connection diagram of the ULM level meter (variant -U) and inside view of the connector

### Connection via PG 11 gland or gland for protective hoses

The ULM level meter or ULS sensor with a B or H type cable gland are connected to processing (display) units by means of a fixed PVC cable 5 m long. PG 11 (B) or plastic bushings with a thread for protective hoses (H) can be used as a cable gland. Connection diagrams are shown in Figures on the right.

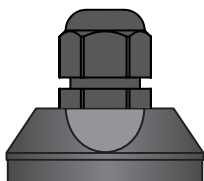

View of the cable gland PG11

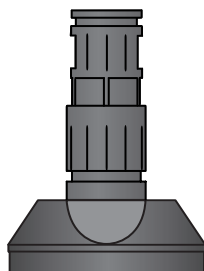

View of the cable gland for protective hose



Connection diagram of the ULM level meter (variant -I) and inside view of the connector

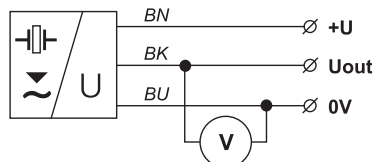

Connection diagram of the ULM level meter (variant -U) and inside view of the connector

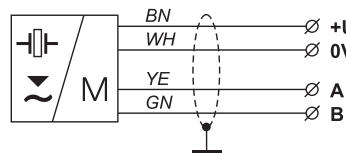

Connection diagram of the level meter with an RS-485 output (variant -M)

#### legend:

BK – black WH – white  
 BU – blue YE – yellow  
 BN – brown GN – green



Wiring operations shall only be carried out without voltage!

Taking into account the potential occurrence of electrostatic discharge on non-conducting parts of the level meter, it is necessary to ground the flange of level meters ULM-53Xi-20-F, located in an explosive atmosphere, using a ground terminal!



It is also necessary to design and take measures to reduce the effects of static electricity to a safe level in the wiring.

Installation in explosive atmospheres needs to be carried out in compliance with ČSN EN 60079-14 (Electrical installations for explosive gaseous atmospheres – Part 14: Electrical installations in dangerous areas other than mining) and possibly also in compliance with other standards relating to the area concerned.



The supply source should be preferably designed as a stabilized source of safe voltage 18 V to 36 V DC (max. 30 VDC for version Xi), which is part of the downstream processing or display system.

In case of strong ambient electromagnetic disturbance, parallel run of the input cable with the power line or its length exceeding 30 m, we recommend using a shielded cable.

## SET-UP ELEMENTS

### Device type with setting using buttons

The measuring range is setup by means of two buttons "DOWN" and "UP". The "DOWN" button is used to enter to the setting mode (setting the 4 mA or 0 V limit) and to decrease the output current or voltage. The "UP" button as an opposite function (setting the 20 mA or 10 V limit and increasing the output current or voltage). Values are confirmed by simultaneous pressing of both buttons for about 1 sec. The setting process is indicated by yellow "STATE" LED indicator.

For detailed information please read at the instructions manual.

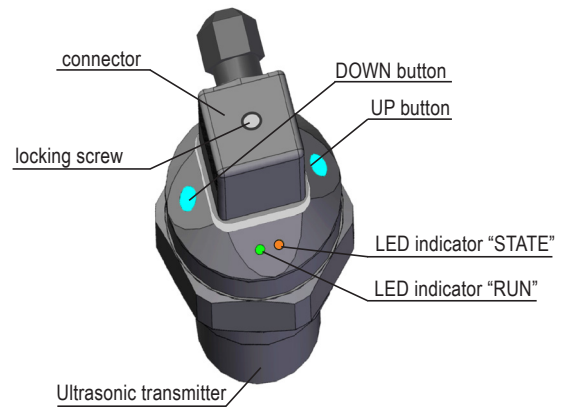

Key parts of the measuring device (version with buttons)

### Device type with setting using a magnetic pen

The measuring range is setup by touching of the magnetic pen to sensitive spots "EMPTY" and "FULL". The "EMPTY" spot is used to enter to the setting mode (setting the 4 mA or 0 V limit) and to decrease the output current or voltage. The "FULL" spot as an opposite function (setting the 20 mA or 10 V limit and increasing the output current or voltage). Values are confirmed by touching of the magnetic pen to the sensitive spot for about 3 sec. The setting process is indicated by yellow "STATE" LED indicator.

For detailed information please read at the instructions manual.

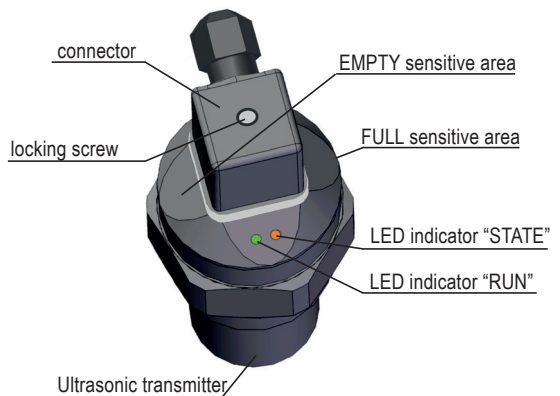

Key parts of the measuring device (version with Hall probes)

## STATUS INDICATION

LED indicator	Colour	Function
"RUN"	green	<p><b>short flashing</b> (repeated depending on the measurement interval approx. 1 ... 2 s) - correct function, receipt of signal (echo) reflected from the measured surface</p> <p><b>fast flashing</b> – the measured surface is in the dead zone of the level meter or the ultrasound transducer is dirty</p> <p><b>off</b> – the level meter is not capable of receiving the echo. Incorrect installation or malfunction</p>
"STATE"	orange	<p><b>ULM-53</b></p> <p><b>slow flashing</b> – 4 mA (0V) threshold setting indication</p> <p><b>fast flashing</b> – 20 mA (10V) threshold setting indication</p> <p><b>3 short flashes</b> – setting confirmation</p> <p><b>ULM-53 variant "M" with Modbus communication</b></p> <p><b>fast flashing</b> – communication under way on line RS-485</p>

## RANGE OF APPLICATION

Thanks to the proximity principle employed, the devices are suitable for continuous or limit measurement of the level of liquids, waste water, sludge, suspensions, adhesives, resins in various open and closed vessels, sumps, open channels and drains. Applicability for measuring the surface level of loose materials is limited, the range of measurement is shorter there.

## ORDER CODE

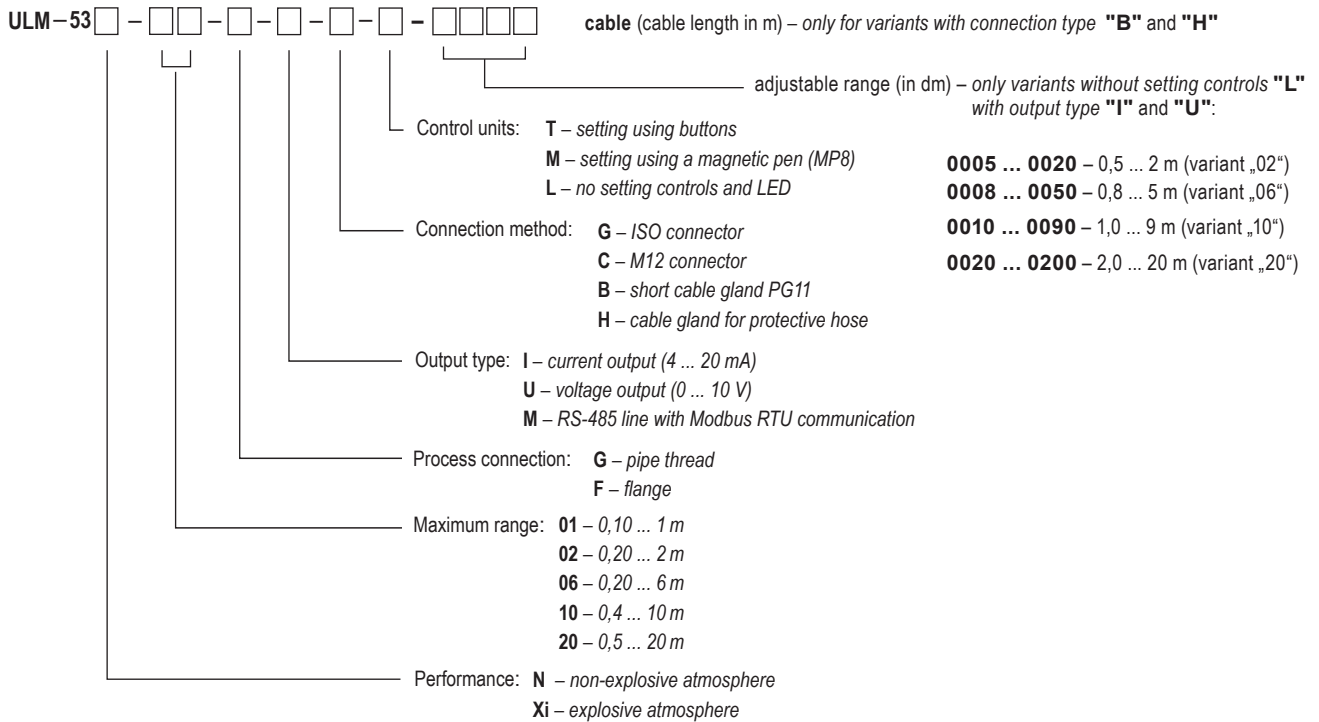

## CORRECT SPECIFICATION EXAMPLES

ULM-53N-02-G-I-G-T  
ULM-53Xi-06-G-I-B-M

ULM-53N-20-F-U-H-M  
ULM-53N-10-G-M-C-L

## ACCESSORIES

### standard

(included in device price)

- 1x seal (for UL\_53\_01; 02; 06, 10)
- 1x connector with IP67 coverage (for versions with an ISO connector)
- 1x magnetic pen MP-8 (for device type adjusted with a magnetic pen)
- free-to-download programme Basic Scada Level (for the Modbus version)

### optional

(for a extra charge)

- stainless steel or plastic fastening nuts G 3/4", G1", G1 1/2" and G2 1/4
- stainless steel or plastic lugs G 3/4", G1", G1 1/2" and G2 1/4
- horn adapter ST-G1 (thread G1"), ST-G1,5 and ST-G2,25
- socket ELWIK 4012 K PG7
- connector with IP67 coverage (type GAN-DADE 7A) with 5m cable (for current output and ISO type connector)
- connector with IP67 coverage (type GAN-DAEE 7A) with 5m cable (for voltage output and ISO type connector)
- converter URC-485 (for the Modbus version)

## MATERIALS

sensor part	type variant	standard material
Case	all	plastic PP
Electro-acoustic transducer	all	plastic PVDF
Flange	ULM-53_-20	aluminium with surface finish (powder coating)
Cable gland	all	plastic PA

## PROTECTION, SAFETY, COMPATIBILITY AND EXPLOSION-PROOF DESIGN

The ULM-53 level meter is equipped with protection against reverse polarity of the supply voltage and against short voltage surges and with protection against current overload at the output.

Protection against dangerous contact is provided by low safe voltage under EN 33 2000-4-41.

Electromagnetic compatibility complies with EN 55011/B, EN 61326-1 and EN 61000-4-2 to 6.

The explosion-proof design of types ULM-53Xi is provided in conformity to the standards: EN 60079-0 : 2007; EN 60079-11 : 2007 and EN 60079-26 : 2007.

Explosion-proof design is certified by FTZÚ-AO 210 Ostrava-Radvanice, Report No.: FTZÚ 09 ATEX 0119X.

A declaration of conformity has been issued for this device in accordance with Act No. 22/1997 Coll., as amended. The supplied electrical device conforms to the applicable government regulations concerning safety and electromagnetic compatibility.

verze 05/2015

