

## Insertion Paddle Wheel type Flow Rate Indicator Totalizer – Series-282

NK Instruments Pvt. Ltd. has Insertion Paddle Wheel type Flow Rate Indicator with Totalizer in 282 series. Those are available in Panel mounted (P-282) and Field Mounted (F 282) versions. The meter has programmable scale factor with direct units for flow rate in M3/hr, LPH, LPM, LPS, GPM us & GPM, uk and totalizer reading in m3, Liters & Gallon. Sizes available from ½” up to 20”. This model have optional Relay output which is operate on Totalizer (used for Batching and Dosing application) on flow rate (used as flow switch)

### **Technical Specifications for Flow Rate Indicating Totalizer (series 282)**

Function	: Flow Rate Indicator and Totalizer
Display	: 16 X 2 LCD display
Supply of Voltage	: 230 V AC
Linearity	: ± 1% of full range
Repeatability	: ± 0.5% of full range
Inputs	: flow sensor (P812)
Configuration Lock	: Password protection
Calibration	: Using front membrane keys
Output	: 5A, 230 V AC max. Potential Free Relay SPDT (Please specify, Relay – on Rate of Flow or, on Total Flow)
Meter size	: 110 X 110 X 150 mm
Cutout Size	: 90 mm X 90 mm
Protection Rating	: Weatherproof to IP65

Similar Meter is available in flameproof version also.

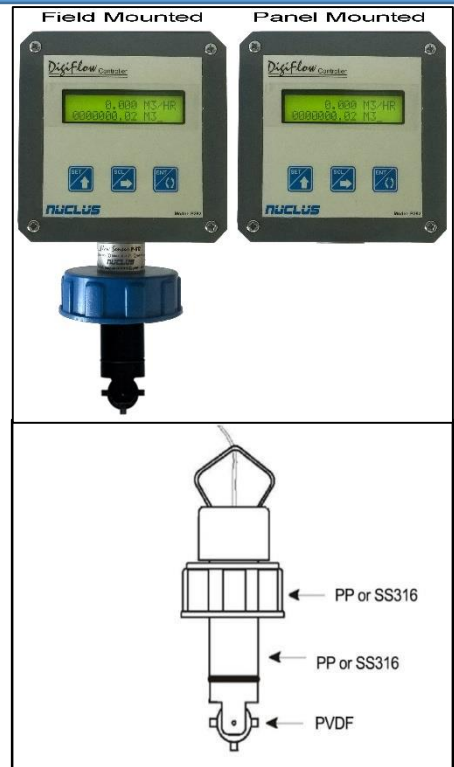

## LINE SIZE SELECTION

Size	15 NB	25 NB	40 NB	50 NB	65 NB	80 NB	100 NB
Min Flow m3/hr	0.23	0.88	2.04	3.50	6.30	8.00	14.0
Max Flow m3/hr	2.60	8.80	20.4	35.0	63.0	80.0	140

## TYPE OF SENSOR INSTALLATION FITTINGS

Weld Block



SS 'T' fitting with  
Threaded end



SS 'T' fitting with  
stub end

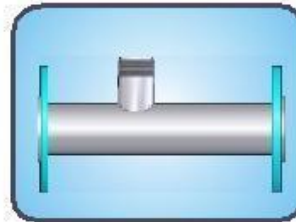

SS T fitting with  
welded flange



Weld Adaptor



DIMENSIONAL DETAILS OF FLOW SENSORS & FITTINGS

TYPE OF FLOW SENSORS

PP FLOW SENSOR

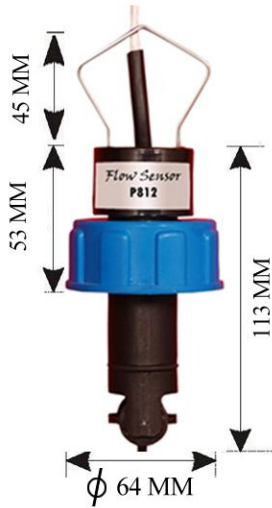

SS FLOW SENSOR

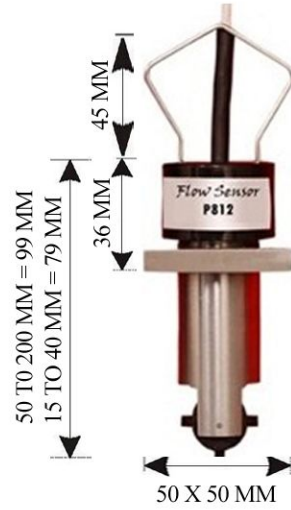

TYPE OF FITTINGS

PLASTIC THREADED END FITTINGS



SIZE	L	H
15 NB	250 MM	88 MM
25 NB	165 MM	100 MM
40 NB	210 MM	115 MM

PLASTIC SOLVENTABLE FITTING

Plastic (ABS) flow sensor installation T fittings with solventable end is available for Line size 1/2" (15 NB), 1" (25 NB) & 1 1/2" (40 NB).



SIZE	L	H
15 NB	90 MM	88 MM
25 NB	110 MM	100 MM
40 NB	130 MM	115 MM

Plastic (PVC) flow sensor installation T fittings with solventable end is available for Line size 2" (50 NB), 2 1/2" (65 NB).

SIZE	L	H
30 NB	142 MM	142 MM
65 NB	165 MM	165 MM

Note: Tolerance level is 1 MM

## TYPE OF FITTINGS

### STUB END FLANGE FITTINGS

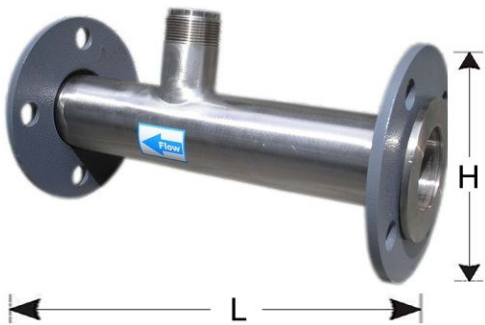

SIZE	L	H
15 NB	270 MM	96 MM
25 NB	270 MM	102 MM
40 NB	250 MM	104 MM
50 NB	300 MM	115 MM
65 NB	350 MM	129 MM
80 NB	450 MM	143 MM
100 NB	500 MM	164 MM

### WELDED FLANGE END FITTINGS



SIZE	L	H
15 NB	270 MM	96 MM
25 NB	270 MM	102 MM
40 NB	250 MM	104 MM
50 NB	300 MM	115 MM
65 NB	350 MM	129 MM
80 NB	450 MM	143 MM
100 NB	500 MM	164 MM

### STAINLESS STEEL THREADED END FITTINGS

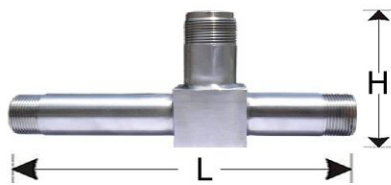

SIZE	L	H
15 NB	270 MM	96 MM
25 NB	275 MM	102 MM
40 NB	250 MM	104 MM

### STAINLESS STEEL BLOCK DESIGN FITTINGS

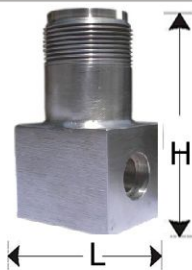

SIZE	L	H
15 NB	55 MM	96 MM
25 NB	55 MM	102 MM

Note: Tolerance level is 1 MM

All type of flow meter requires straight run, as per site condition following straight pipe lengths must be provided for best result.

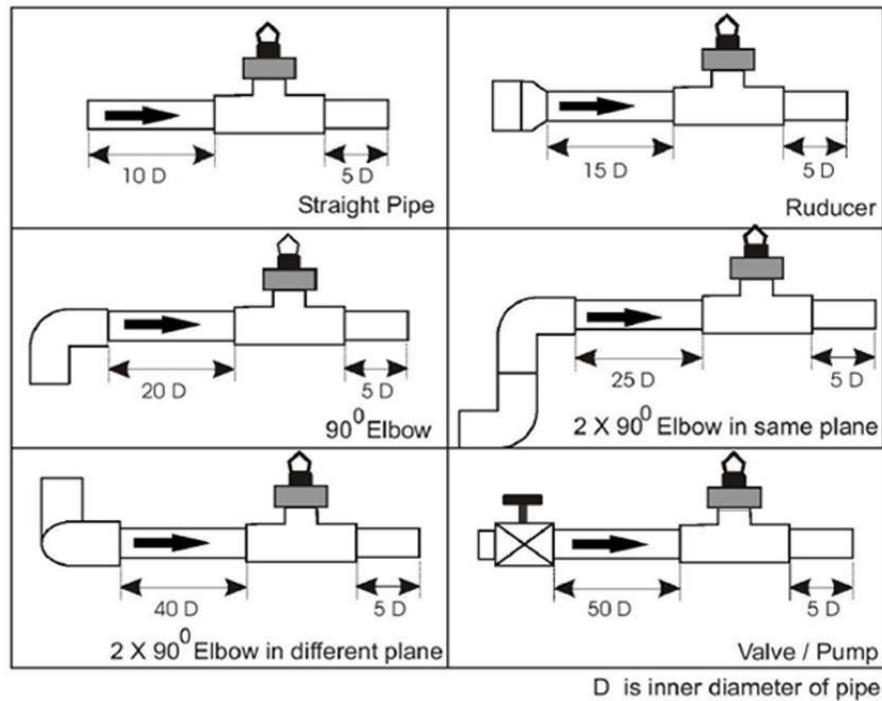

Continuous efforts for product development may necessitate changes in these details without notice

Authorised Dealer



*NK Instruments Pvt. Ltd.*

B-501/504, 5th floor, Raunak Arcade, Near THC Hospital, Gokhale Road, Naupada,  
Thane(W) 400602. Maharashtra INDIA      Telefax Nos.: 91-22-25301330 / 31 / 32  
E-Mail: sales@nkstruments.com      Web: <http://www.nkstruments.com>  
Skype: nitinkelkarskype      Gtalk: nkstruments2006

