



CE

Special Features

- Stainless steel case & measuring system
- Selectable ranges from
From -1 to 14 Bar Pressure and Vacuum & Compound
- Flanged or screwed connection
- Standard followed in general EN 837 - 3
- C E approved electrical contacts

Application

- Suitable for clean air
- Corrosive environments & Gaseous or non crystallized liquid media that will not obstruct the pressure system.

Specifications

Standard Version : 100 mm & 150 mm

Diaphragm Type	:	-1 to 14 bar Pressure and Vacuum
Accuracy	:	±1.6% of F. S.
Ambient temperature	:	-25°C to +65°C
Process temperature	:	Max 100°C
Operating pressure range	:	75% of Scale Value
Over pressure limit	:	125% of Scale Value

Case & bezel	:	AISI 304 SS (Bayonet Type)
Top chamber	:	MS Powder Coated
Bottom chamber	:	AISI 316 SS
Movement	:	AISI 304 SS
Diaphragm	:	Spring Steel With PTFE Coated
Gauge connection	:	½" BSP (M)

Protection	:	IP 68
Dial	:	Aluminum, black graduation on white background
Pointer	:	Aluminum, black coloured, micrometer zero adjustable
Window	:	Toughened Glass
Blow off Disc	:	Neoprene
Gasket	:	Neoprene

Electrical contact - dry version

Accuracy	:	±2.5% of F.S.
Ambient Temperature	:	Maximum 65°C
Process Temperature	:	Maximum 65°C
Window	:	Polycarbonate Dome
Electrical Contacts*	:	Refer how to order
Other Features	:	Refer specification of standard version

* Please specify contact set points while ordering.

Temperature effect :

The variation of indication caused by effects of temperature is to be calculated by below formula; which is to be added in the specified accuracy while measurement :- Formula : $\pm 0.08 \times (t_2 - t_1) \% \text{ of F. S.}$ where t_1 = reference temperature (+20°C) and t_2 = ambient temperature in °C.

Note : The addition of mechanical electric contacts affects the accuracy of instruments such that 1% becomes 1.5%, 1.6% becomes 2.4% etc. (Add the 50% of accuracy; If the contact is of the magnetically assisted type, this value can't be added within the ±5% of setting point.)

Dimensions - standard version

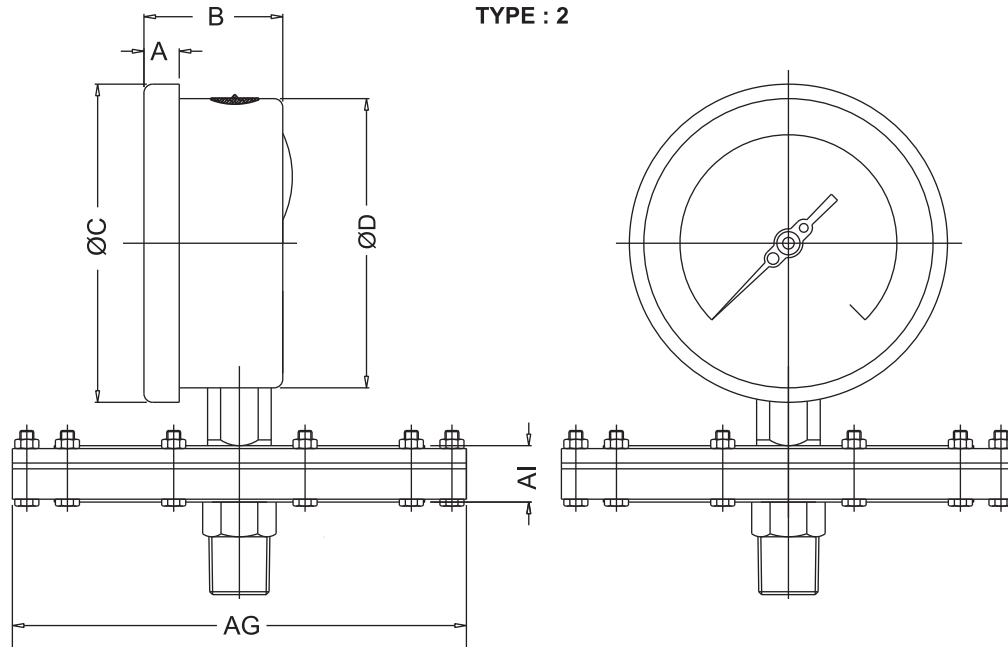

NS	A	B	ØC	ØD	AG	AI	Weight in gram (With Box)
100	12.5	48	111	100	98	16	2600
150	15.5	48	161	149	98	16	3080

Notes : • Drawings are not to scale.
• All Dimensions are in mm.
• NS = Nominal Size.

Range Table

Note : We offer National / International Scales like kPa, MPa, bar, psi, kg/cm² & Dual Scale like kPa with psi, kPa with bar, bar with psi or Equivalent scales as per the requirement can be provided on request. Following are the example tables for kg/cm² & psi scales

Pressure, Vacuum & Compound Ranges

Pressure range

Single scale (kg/cm ²)				Dual scale psi with kg/cm ²			
0/0.6	0/1.6	0/4	0/10	psi	kg/cm ²	psi	kg/cm ²
0/1	0/2.5	0/6		0/15	0/1	0/100	0/7
				0/30	0/2	0/150	0/10
				0/60	0/4	0/200	0/14

Vacuum & Compound range

Single scale (kg/cm ²)			Dual scale kg/cm ² with psi			
-1/0.6	-1/3	-1/9	inHg with psi	mmHg with kg/cm ²	inHg with psi	mmHg with kg/cm ²
-1/1.5	-1/5		-30/0	-760/0	-30/60	-760/4
			-30/15	-760/1	-30/100	-760/7
			-30/30	-760/2	-30/150	-760/9

Range Table

Wiring diagrams for electric contacts

Single Contact

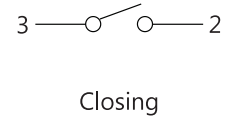
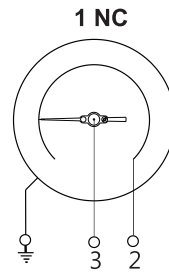
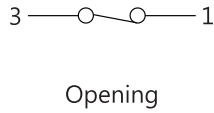
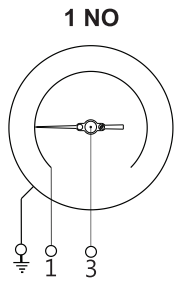

Double contact

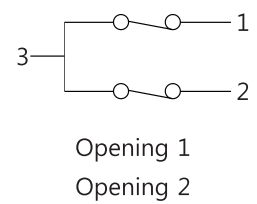
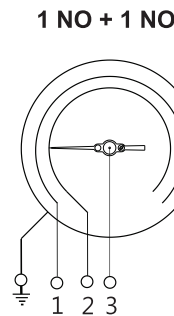
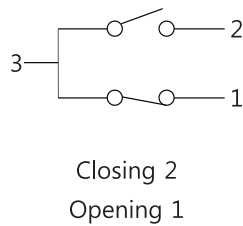
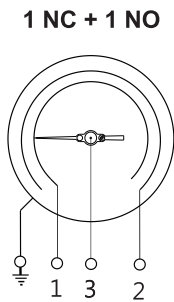
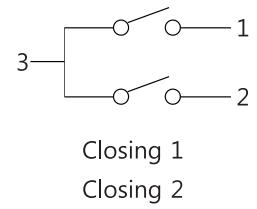
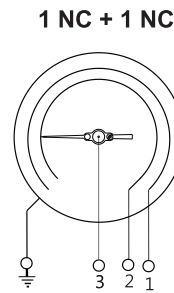
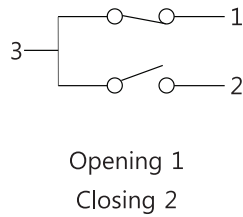
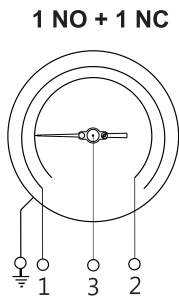

Flange Table

Flange table with ordering codes,

E.g. For flange size of 1" as per BS-10 table E with raised face : B97 - A2 (A2 Raised face A3 Flat face)

As per DIN 2527

DN	PN	CODE	
10	6	A01	
	10	A02	
	16	A03	
	25	A04	
	40	A05	
	64	A06	
	100	A07	
	160	A08	
	250	A09	
	400	A10	
15	6	A11	
	10	A12	
	16	A13	
	25	A14	
	40	A15	
	64	A16	
	100	A17	
	160	A18	
	250	A19	
	400	A20	
20	6	A21	
	10	A22	
	16	A23	
	25	A24	
	40	A25	
	64	A26	
25	10	A27	
	16	A28	
	25	A29	
	40	A30	
	64	A31	
	100	A32	
32	160	A33	
	250	A34	
	400	A35	
	40	6	A36
		10	A37
		16	A38
25		A39	
40		A40	
64		A43	
50	100	A47	
	160	A48	
	250	A49	
	400	A50	
	6	A51	
	10	A52	
60	16	A53	
	25	A54	
	40	A55	
	64	A56	
	100	A57	
	160	A58	
70	250	A59	
	400	A60	

DN	PN	CODE
65	6	A61
	10	A62
	16	A63
	25	A64
	40	A65
	64	A66
	100	A67
	160	A68
	250	A69
	400	A70
80	6	A71
	10	A72
	16	A73
	25	A74
	40	A75
	64	A76
	100	A77
	160	A78
	250	A79
	400	A80

As per JIS - B 2210

NOMINAL SIZE	RATING /CLASS	CODE
10A	5K	B57
	10K	B58
	40K	B59
15A	5K	B60
	10K	B61
	40K	B62
20A	5K	B63
	10K	B64
	40K	B65
25A	5K	B66
	10K	B67
	40K	B68
32A	5K	B69
	10K	B70
	40K	B71
40A	5K	B72
	10K	B73
	40K	B74

As per DIN 2642

DN	PN	CODE
10	10	A90
15		A91
20		A92
25		A93
32		A94
40		A95
50		A96
65		A97
80		A98

As per DIN 2633

DN	PN	CODE
10	16	A81
15		A82
20		A83
25		A84
32		A85
40		A86
50		A87
65		A88
80		A89

As per DIN 2635

DN	PN	CODE
10	40	A99
15		B01
20		B02
25		B03
32		B04
40		B05
50		B06
65		B07
80		B08

NOMINAL SIZE	RATING /CLASS	CODE
50A	5K	B75
	10K	B76
	40K	B77
65A	5K	B78
	10K	B79
	40K	B80
80A	5K	B81
	10K	B82
	40K	B83

As per ANSI B 16.5

NOMINAL SIZE	RATING /CLASS	CODE
1/2"	150	B09
	300	B10
	600	B11
	900	B12
	1500	B13
	2500	B14
3/4"	150	B15
	300	B16
	600	B17
	900	B18
	1500	B19
2500	B20	
1"	150	B21
	300	B22
	600	B23
	900	B24
	1500	B25
	2500	B26
1 1/4"	150	B27
	300	B28
	600	B29
	900	B30
	1500	B31
	2500	B32
1 1/2"	150	B33
	300	B34
	600	B35
	900	B36
	1500	B37
	2500	B38
2"	150	B39
	300	B40
	600	B41
	900	B42
	1500	B43
	2500	B44
2 1/2"	150	B45
	300	B46
	600	B47
	900	B48
	1500	B49
	2500	B50
3"	150	B51
	300	B52
	600	B53
	900	B54
	1500	B55
	2500	B56

As per BS - 10

NOMINAL SIZE	TABLE	CODE
1/2"	D	B84
	E	B85
	F	B86
	H	B87
	J	B88
	K	B89
3/4"	D	B90
	E	B91
	F	B92
	H	B93
	J	B94
	K	B95
1"	D	B96
	E	B97
	F	B98
	H	B99
	J	C01
	K	C02
1 1/4"	D	C03
	E	C04
	F	C05
	H	C06
	J	C07
	K	C08
1 1/2"	D	C09
	E	C10
	F	C11
	H	C12
	J	C13
	K	C14
2"	D	C15
	E	C16
	F	C17
	H	C18
	J	C19
	K	C20
2 1/2"	D	C21
	E	C22
	F	C23
	H	C24
	J	C25
	K	C26
3"	D	C27
	E	C28
	F	C29
	H	C30
	J	C31
	K	C32

- Note : 1 Flanged Connections as per BS / ANSI / DIN etc standards with or without Teflon protection can be provided on request.
2 Flange Finish shall be 125 - 250 AARH as a standard. For other finish, please consult factory.

How To Order							Example																																		
Basic Model							SCH																																		
Code																																									
Nominal Size				40	60																																				
				100 mm	150 mm		XX																																		
Type of Mounting																																									
2	Direct bottom entry		6	2" pipe / yoke mounting with bottom entry*			X																																		
* MOC of bracket and 'U' clamp will be steel. Ask factory for drawings, if required.																																									
Top Chamber																																									
MS	MS Powder Coated (Standard)		S6	AISI 316 SS			XX																																		
Diaphragm																																									
SP	Spring Steel With PTFE Coated (Standard)						XX																																		
Bottom Chamber (* Refer Pressure v/s Temperature table below.)																																									
S4	AISI 304 SS						XX																																		
SL	AISI 316L SS																																								
S6	AISI 316 SS (Standard)																																								
PC	PVC*																																								
PZ	PVDF*																																								
PP	Polypropelene*																																								
<table border="1"> <thead> <tr> <th rowspan="2">MOC of Bottom Chamber</th> <th colspan="6">Pressure V/S Temperature</th> </tr> <tr> <th>20 °C</th> <th>40 °C</th> <th>60 °C</th> <th>80 °C</th> <th>100 °C</th> <th>120 °C</th> </tr> </thead> <tbody> <tr> <td>PVDF</td> <td>10 kg/cm²</td> <td>10 kg/cm²</td> <td>10 kg/cm²</td> <td>7 kg/cm²</td> <td>4 kg/cm²</td> <td>2 kg/cm²</td> </tr> <tr> <td>PP</td> <td>10 kg/cm²</td> <td>10 kg/cm²</td> <td>6 kg/cm²</td> <td>4 kg/cm²</td> <td>1 kg/cm²</td> <td>NA</td> </tr> <tr> <td>PVC</td> <td>10 kg/cm²</td> <td>10 kg/cm²</td> <td>4 kg/cm²</td> <td>1 kg/cm²</td> <td>NA</td> <td>NA</td> </tr> </tbody> </table>							MOC of Bottom Chamber	Pressure V/S Temperature						20 °C	40 °C	60 °C	80 °C	100 °C	120 °C	PVDF	10 kg/cm ²	10 kg/cm ²	10 kg/cm ²	7 kg/cm ²	4 kg/cm ²	2 kg/cm ²	PP	10 kg/cm ²	10 kg/cm ²	6 kg/cm ²	4 kg/cm ²	1 kg/cm ²	NA	PVC	10 kg/cm ²	10 kg/cm ²	4 kg/cm ²	1 kg/cm ²	NA	NA	
MOC of Bottom Chamber	Pressure V/S Temperature																																								
	20 °C	40 °C	60 °C	80 °C	100 °C	120 °C																																			
PVDF	10 kg/cm ²	10 kg/cm ²	10 kg/cm ²	7 kg/cm ²	4 kg/cm ²	2 kg/cm ²																																			
PP	10 kg/cm ²	10 kg/cm ²	6 kg/cm ²	4 kg/cm ²	1 kg/cm ²	NA																																			
PVC	10 kg/cm ²	10 kg/cm ²	4 kg/cm ²	1 kg/cm ²	NA	NA																																			
Process Connection																																									
4NM	½" NPT (M) (Standard)		4TM	½" BSPT (M)		3BM	3/8" BSP (M) (Except Option PLF)	XXX																																	
4BM	½" BSP (M) (Standard)		4MM	M20 x 1.5 (M)		Flanged*	Refer Flange Table with ordering code on previous page																																		
Note : Connections like Metric/ PT/ PF/ Flaired/ UNF/ G/ R etc. can be provided on request. * ask factory for drawings, if required.																																									
Range																																									
Refer range table							0/250 mmWC																																		
Optional extras																																									
CDD	Custom designed dial			PLF	PTFE lining on flange or screwed connection*		XXX																																		
STG	Shatterproof / safety glass			SPD	Silver protection on diaphragm																																				
TND	Tag No Marking on Dial			PPD	PTFE protection on diaphragm**																																				
STP	SS tag plate			PCD	PTFE coating on diaphragm																																				
TCS	Top chamber in AISI 316 SS			PTG	PTFE gasket upto 200°C																																				
OXS	Oxygen service			MOS	AISI 316 SS movement																																				
PY4	2" pipe/yoke mounting bracket & 'U' clamp (AISI 304 SS)			CBS	AISI 316 SS case & bezel																																				
PYS	2" pipe/yoke mounting bracket & 'U' clamp (AISI 316 SS)			MTC	Material test certificates#																																				
* For screwed connection, bore diameter will be minimum 10 mm. ** Suitable for Pressure Ranges only.																																									
# Material test certificates will be provided for wetted parts only with chemical composition testing. For others, please consult factory.																																									
Electric Contacts (CE Approved)																																									
(For dry version, with ingress protection up to IP 55 & poly carbonate dome as a window)																																									
A) Single insulated magnetic snap action type (230 V AC, 1 Amp.)(48 V DC, 0.5 Amp.) (Available for 1000 mmwc & above)				B) Inductive type (220 V AC, 0.4 Amp.) (Available for 1000 mm WC & above)																																					
M1	Single; normally closed (1 NC)			D1	Single; normally open (1 NO)		XX																																		
M2	Double; normally closed + normally open (1 NC + 1 NO)			D2	Single; normally closed (1 NC)																																				
M3	Single; normally open (1 NO)			D3	Double; normally closed + normally open (1 NC + 1 NO)																																				
M4	Double; normally open + normally closed (1 NO + 1 NC)			D4	Double; normally open (both NO)																																				
M5	Double; normally closed (both NC)			D5	Double; normally closed (both NC)																																				
M6	Double; normally open (both NO)			D6	Double; normally open + normally closed (1 NO + 1 NC)																																				
Note: the scale amplitude will be in between 180° to 270° & window shall be polycarbonate dome.																																									
Ordering Example: SCH- XX - X - XX - XX - XX - XXX . 0/10 Bar - XX - XXX - XX																																									
For non standard products/optional items, please contact factory for delivery and minimum quantity of order.																																									
Refer Datasheet FR for selection of Flushing Rings.																																									
Note : Specifications and dimensions given in this product catalogue represents the state of engineering at the time of printing. Modifications may take place and materials specified may be replaced by others without prior notice.																																									